



Instant Pot's 4 Superpowers

HOW TO PLAN FOR A SECURE RETIREMENT

THE HEALTH RISKS OF 'NATURAL' MEDICINE

CR Consumer Reports™

MARCH 2018

REVIEWS & RATINGS

- Grills
- Door Locks
- Stick Vacs
- Drones
- BMW X3



The Best Mattress For You

Find it inside!

- ▶ **116 Models** Tested & Rated
- ▶ Top Picks for **Foam, Innerspring, Adjustable Air**
- ▶ When & How to **Get a Great Price**
- ▶ Best Bets for a **Bed-in-a-Box**

Smarter choices for a better world

CR.ORG

Looking for the **Safest Cars** or the **Best Appliances?**

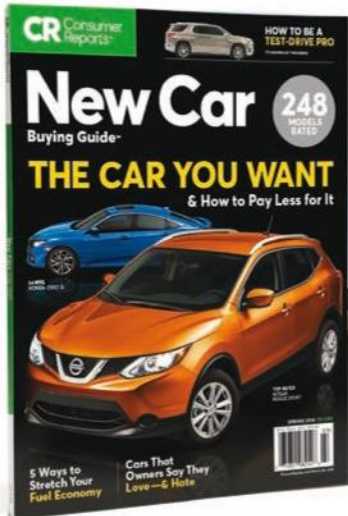

**Get independent, unbiased information
you trust from Consumer Reports**

These special publications are on sale now
at newsstands nationwide or online at cr.org/books



DEPARTMENTS
& COLUMNS

8 What We're Testing in Our Labs ...
Toaster ovens, tablets, frying pans, stick vacuums, and more.

RATINGS



BREVILLE SMART OVEN PRO

10 Ask Our Experts
The reason you shouldn't skip smart-TV updates, why it's not too late to get the flu shot, and how likely you are to be audited.

11 CR Insights
Product picks and practical advice, including the most pick-resistant door locks, fast-heating grills, and the Instant Pot's four best functions.

RATINGS



MEDECO MAXUM

PRODUCT UPDATES

18 Taking Photos on the Fly
Drones are now more reliable and easier to use for aerial photography. Our testers reveal which will make you the happiest palm pilot.

RATINGS

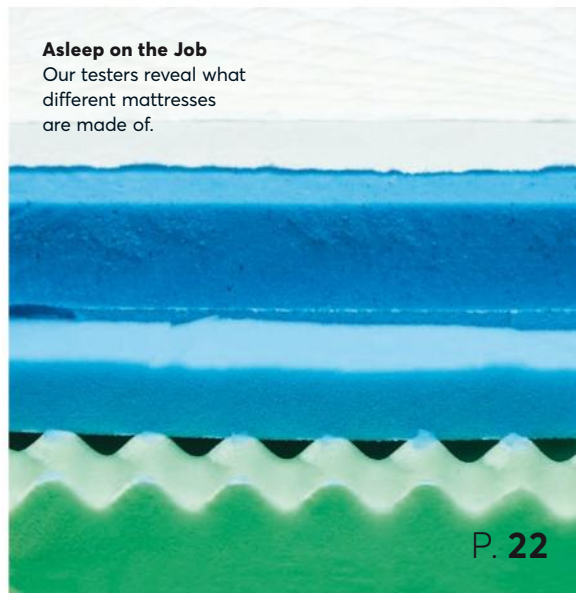

Asleep on the Job
Our testers reveal what different mattresses are made of.

P. 22

FEATURES

COVER STORY

22 Find the Best Mattress for You
Does mattress shopping drive you mad? Our ratings of 116 models—from foam to innerspring—are sure to help.

RATINGS

36 Could This Cell Save Your Life?
Stem cell therapy works for a few choice conditions, but consumers are being offered treatments that are ineffective or even dangerous. What you need to know to stay safe.

42 Planning for a Secure Retirement
Do you know when you'll have enough money to stop working? Use our savvy strategies to take control and feel confident, no matter what your age.

48 The ____ Will See You Now
As we face a growing doctor shortage, we're all likely to encounter unfamiliar medical practitioners, from P.A.s to N.P.s. Learn what they're qualified to do—and not—and why seeing a naturopath may be a dicey decision.

IN EVERY ISSUE

4 From the President: Your Mattress Matters
The mattress industry has experienced a needed shake-up with the bed-in-a-box business model. And our rigorous testing will help you rest easy.

5 Building a Better World, Together
Supporting a new bill to reduce arsenic in rice, fighting for fair auto-insurance pricing, and raising concerns about the AT&T and Time Warner merger.

6 Your Feedback
Readers' comments about our recent content.

17 Recalls

62 Index

63 Selling It
Goofs and gaffes.

ROAD REPORT

58 Road Test
We rate four luxury SUVs: the BMW X3, Buick Enclave, GMC Terrain, and Land Rover Range Rover Velar.

RATINGS



BMW X3

ABOUT CONSUMER REPORTS
We are the world's largest independent, nonprofit consumer-product-testing organization, based in Yonkers, N.Y. We survey hundreds of thousands of consumers about their experiences with products and services. We pay for all the products we rate. We don't

accept paid advertising. We don't accept free test samples from manufacturers. We do not allow our name or content to be used for any promotional purposes.
HOW TO REACH US
Write to us at Consumer Reports, 101 Truman Ave., Yonkers, NY 10703, Attn.: Customer Service.

TO SEND A LETTER TO THE EDITOR
Go to CR.org/lettertoeditor.
NEWS TIPS AND STORY IDEAS
Go to CR.org/tips.
EMAIL SUBMISSIONS
For Selling It send items to SellingIt@cro.consumer.org or call 800-333-0663. See page 63 for more details.

SUBSCRIPTION INFORMATION
Go to CR.org/magazine or call 800-333-0663. See page 61 for more details.
RATINGS Overall scores are based on a scale of 0 to 100. We rate products using these symbols:
 ⚠️ POOR ⚡ FAIR 🟡 GOOD
 🟢 VERY GOOD 🟩 EXCELLENT

Your Mattress Matters



IN RECENT YEARS it has seemed that no industry is safe from being upended and reimaged by new challengers offering innovative solutions to familiar problems. That's precisely what has happened in the mattress industry, as startups have emerged to challenge the status quo of the walk-in mattress outlet by marketing affordable bed-in-a-box options for customers who would rather shop online than deal with

the hassles of an in-store sales pitch. These upstarts are gaining traction, too: Direct-to-consumer mattress companies have reportedly doubled their market share since 2014, and their annual retail sales have jumped from \$852 million two years ago to \$1.8 billion today.

At CR, we always have our eyes open for new business models like beds-in-a-box that spring up to challenge sleepy industries. That's why we're peering under the covers to get you the information you need on both new and traditional mattresses so that you can make the right choice and avoid a shopping nightmare. Our blanket coverage includes ratings of 116 foam, innerspring, and adjustable air mattresses, including 41 bed-in-a-box options that may help you avoid the headaches and prices of past purchases. We put products through their paces because helping you rest easy, knowing you have the independent knowledge you need to make smart choices, is at the core of our mission at CR—and if you wind up literally resting more easily as a result, we sleep better at night, too.

Marta Tellado

Marta L. Tellado,
President and CEO
Follow me on Twitter
@MLTellado

President and CEO Marta L. Tellado

Senior Vice President, Brand & Strategy Leonora Wiener
Vice President, Chief Content Officer Gwendolyn Bounds

Editor in Chief Diane Salvatore

Executive Editor Kevin Doyle

Features Editor Natalie van der Meer

Design Director Matthew Lenning **Creative Director, Brand** Young Kim
Associate Design Director Mike Smith

Manager, Art Operations Sheri Geller

Art Directors Tammy Morton Fernandez, Ewelina Mrowiec, Lisa Slater, Tracy Stora
Photo Editors Emilie Harjes, Karen Shinbaum

Director, Content Development Glenn Derene

Deputy Director, Content Development Christopher Kirkpatrick

Senior Director, Product Testing Mark Connelly

Director, Content Impact & Corporate Outreach Jen Shechter

Director, Special Projects Sandy Keenan

Deputies, Special Projects Lisa Gill, Joel Keehn

Associate Director, Content Development Scott Billings

Cars

Patrick Olsen, Content Lead

Editors: Jeff S. Bartlett,

Nick Kurczewski, Jonathan Linkov,

Mike Monticello, Jeff Plungis

Auto Test Center: Jake Fisher,

Jennifer Stockburger, Directors

Product Testers: Mike Bloch, John

Ibbotson, Chris Jones, Anita Lam,

Gene Petersen, Ryan Pszczolkowski,

Mike Quincy, Gabe Shenhar,

Shawn Sinclair, Emily A. Thomas,

Joe Veselak, Seung Min "Mel" Yu

Policy Lead: David Friedman

Home & Appliance

Eric Hagerman, Content Lead

Editors: Mary Farrell, Paul Hope,

Kimberly Janeway, Sara Morrow,

Haniya Rae, Daniel Wroclawski

Product Testers: John Galeotafore,

James Nanni, Testing Leads; Peter

Anzalone, John Banta, Susan Booth,

Tara Casaregola, Lawrence Ciufu,

Enrique de Paz, Bernard Deitrick,

Cindy Fisher, Emilio Gonzalez, Ginny

Lui, Joan Muratore, Joseph Pacella,

Christopher Regan, Frank Spinelli,

David Trezza, Michael Visconti

Electronics

Jerry Beilinson, Content Lead

Editors: Tercius Bufete, Nicholas

Deleon, Bree Fowler, Christopher

Raymond, Allen St. John, James Willcox

Product Testers: Maria Rerecich,

Testing Lead; Elias Arias,

Antonette Asedillo, Claudio Ciacci,

Charles Davidman, Richard

Fisco, Richard Sulin, Maurice Wynn

Policy Lead: Justin Brookman

Health & Food

Ellen Kunes, Content Lead

Editors: Orly Avitzur, M.D.; Julia

Calderone; Trisha Calvo; Lauren F.

Friedman; Chris Hendel; Jesse Hirsch;

Jeneen Interlandi; Marvin M.

Lipman, M.D.; Catherine Roberts;

Diane Umansky **Product Testers:**

Maxine Siegel, Testing Lead;

Amy Keating, Ellen Klosz

Money

Margot Gilman, Content Lead

Editors: Octavio Blanco, Jeffrey Blyskal,

Anthony Giorgianni,

Nikhil Hutheesing, Donna Rosato,

Tobie Stanger, Penelope Wang

Policy Lead: Anna Laitin

Chief Scientific Officer James H. Dickerson

Food Safety James Rogers, Director; Sana Mujahid;

Henry Akinleye, Charlotte Vallaeys

Product Safety Don Huber, Director; Doris Sullivan, Associate Director

Health Ratings Doris Peter, Director

Content Systems & Operations Strategy Peter Meirs, Director

Content Operations David Fox, Director; William Breglio; Anthony Terzo

Production Eric W. Norlander, Manager; Letitia Hughes, Terri Kazin

Imaging Francisco Collado, Mark Linder

Content Coordination Nancy Crowfoot; Diane Chesler, Aileen McCluskey

Copy Editing Leslie Monthan, Copy Chief;

Noreen Browne, Alison France, Wendy Greenfield

Fact Checking David Schipper, Manager; Kathleen Adams, Tracy Anderman,

Sarah Goralski, Christine Gordon, Lee Anna Jackson, Sharon MacBride Riley

Administration Decarris Bryant

Consumer Engagement Testing Charu Ahuja, Director; Linda Greene, Adam Kaplan

Statistics Michael Saccucci, Director; Andrew Cohen,

Keith Newsom-Stewart, Martin Romm

Survey Research Karen Jaffe, Simon Slater; Dave Gopoian, Kendra Johnson,

Debra Kalensky, Martin Lachter, Jane Manweiler, Olufemi Olu-Lafe, Adam Troy

Administration John McCowen

Consumer Insight Monica Liriano, Associate Director;

Frank Yang; Chris Holmes, Teneisha Thomas

Newsstand Marketing Patricia McSorley, Associate Director

Procurement Operations Steven Schiavone, Associate Director

Vice President, Chief Communications Officer Matt Anchin; **Vice President,**

Financial Planning & Analysis JoAnne Boyd; **Vice President, Human Resources**

Lisa Cribari; **Vice President, Data & Marketing Operations** Brent

Diamond; **Vice President, Chief Digital Officer** Jason Fox; **Vice President,**

Research, Testing & Insights Liam McCormack; **Vice President, Business Strategy**

& Planning Betsy Parker; **Vice President, Consumer Policy & Mobilization** Jessica

Rich; **Vice President, General Counsel** Steven Schwartz; **Vice President, Chief**

Marketing Officer Kim Stehle; **Vice President, Development** Shar Taylor;

Vice President, Chief Financial Officer Eric Wayne

Reducing Arsenic in Rice

WHAT'S AT STAKE

We've known for years that consumers unwittingly ingest unhealthy amounts of a known carcinogen—arsenic—when eating certain rice and rice-based products.

That's why CR is supporting a new bill, the Reducing food-based Inorganic Compounds Exposure (RICE) Act, that would require the Food and Drug Administration to set a maximum permissible level of inorganic arsenic for rice. "The FDA has a responsibility to ensure [that] our food supply is safe, especially for infants and children, but there are currently no limits on the amount of arsenic allowed in our food," says the bill's sponsor, Rep. Rosa DeLauro, D-Conn. "That is why Congress must take up the RICE Act to protect all Americans' health and well-being."

HOW CR HAS YOUR BACK

Testing by CR brought the problem to public attention, first in 2011 with regard to apple and grape juices, then in 2012 and 2014 for rice products. The FDA issued draft guidance to manufacturers in 2013 and 2016 but has yet to finalize it, let alone impose mandatory limits.

In December a national alliance of scientists and child-health advocates called Healthy Babies Bright Futures built on CR's tests, finding that infant rice cereal contains an average of six times the level of arsenic as other grain cereals.

Jean Halloran, CR's director of food policy initiatives, says the new bill, if passed, would be "an important step forward for public health."

WHAT YOU CAN DO

Until the bill is passed, limit babies to no more than ¼ cup of infant rice-based cereal per day, and include in their diets cereals that are made of wheat, oatmeal, and corn, which contain significantly lower

levels of arsenic. Go to CR.org/arsenic0318 for more dietary guidance. And contact your representatives at congress.gov to urge them to vote for the RICE Act.

Fair Pricing in Auto Insurance

WHAT'S AT STAKE

A new rule in New York state represents an important step toward fairness in the auto-insurance market.

The problem it targets is this: Insurance companies increasingly consider non-driving factors—including credit scores, gender, and ZIP codes—when setting individual policy prices. As a result, many safe drivers pay more than relatively risky ones. And studies have found that the use of these factors raises rates for low-income and minority drivers disproportionately.

New York's Department of Financial Services decided to hit the brakes on this practice by forbidding the use of education or occupation as a factor in setting premiums.

HOW CR HAS YOUR BACK

CR has fought the use of nondriving factors in auto-insurance pricing for years. Our September 2015 cover story, "The Truth About Car Insurance," further highlighted the problem. And a 2017 investigation by CR and ProPublica, "A World Apart," published in our July 2017 issue, found that people in some predominantly minority neighborhoods were consistently charged more than those in white neighborhoods, even when risk levels were the same. That report prompted California regulators to review state filings and require two insurers to adjust rates.

In New York, CR and other consumer groups asked the Department of Financial Services

to do its own investigation. That effort led to the new rule, which officially went into effect in January.

WHAT YOU CAN DO

Check out strategies for saving on auto insurance and find our insurance-company ratings at CR.org/autoinsurance0318.

Seeking More Media Choices

WHAT'S AT STAKE

We took notice in late 2016 when AT&T, the world's largest pay-TV company, announced a plan to buy Time Warner, the media powerhouse that's home to CNN, HBO, TNT, and the Hollywood studio Warner Bros., for \$85 billion.

Our concern was that the merger would limit consumer choice and drive up the cost of accessing news and entertainment. It also raised the possibility that a new combined company might give priority to Time Warner programming or slow competitors' content on its set-top boxes and internet connections, giving it unfair leverage and driving up consumer costs even further.

The Department of Justice, which must approve mergers like this, agreed. It filed a lawsuit to block the merger of AT&T and Time Warner, citing antitrust and competitive concerns.

HOW CR HAS YOUR BACK

Leading up to the decision, CR continually spoke out on behalf of consumers, meeting with Department of Justice and congressional staff members to raise concerns about the deal's impact. We also submitted a statement to a Senate hearing, arguing that market competition benefits consumers far more than monopolies do.

WHAT YOU CAN DO

While the suit winds through the court system, check out our cable and internet provider ratings at CR.org/internetservice0318 to find the best provider in your area.





Readers had lots of opinions about our January 2018 article on robotic vacuums, **“Clean Sweep,”** sharing advice, tips, and even pet names for their bots. To join the discussion, go to [CR.org/vacs0318](https://www.consumerreports.org/vacs0318).

I HAVE WOOD FLOORS; a Lhasa Apso that sheds long, fine hairs; and a tight budget. I bought an iLife V3s for \$160, and it has done a terrific job of cleaning up the dust and hair. I run it two to three times a week, and my floors haven't been so clean in years. Its one failing is that it has ambitions beyond its navigational abilities; it often gets stuck. So I don't run it when I'm away from home. And it can't reach into small spaces. I plan to supplement it with a handheld vacuum for edges, crevices, and upholstery. My upright vacuum is better for carpets but is inconvenient. If I find a

good handheld, I'll happily find a new home for the upright.
—Donna McMaster, via CR.org

EDITOR'S NOTE *If you're in the market for a handheld vacuum, we'd suggest checking out the Shark Pet Perfect II SV780, \$60. It's currently our top-rated handheld model, and we found that it performed excellently on edges; it did a great job on pet hair, too. For readers looking for something in between an upright and a handheld cleaner, turn to page 8 for some of our latest picks in cordless stick vacuums.*

IN YOUR ARTICLE about robotic vacuums, your review of the Neato Botvac D Series stated a “short average run time of 15 minutes.” We have had our D Series Neato for several months, running every other day on medium-pile carpet (other than kitchen and bathroom). Without fail, it runs a full 60 minutes, almost to the

minute every time, completely cleaning our downstairs. We couldn't be happier with it. We even named it: Scooter.
—Sharon Rose, Santa Susana, CA

EDITOR'S NOTE *The run time that we noted in our article is not the time that the battery runs to depletion. Rather, it's the average time the robot vacuum “thinks” it has completed cleaning our lab's 12x16-foot room setups, roughly bedroom-sized and living-room-sized areas. If you have larger areas, multiple rooms, or more obstacles, your robot vacuum may take longer than our average to complete its cycle.*

I LOVE MY Samsung Powerbot. It has great suction, and I use it almost every day. I'm allergic to dust mites and have tried air filters, but this is the only thing that has really helped me. You still need to use an upright occasionally around baseboards, etc., but the

Samsung has a square front, so it does get into corners. I would never use my upright that often, as it is such a pain to use. They are not cheap, but they're worth the money if you have allergies.
—Connie Clark Vogel, via Facebook

Nothing to Sneeze At

IF THEY GIVE an award to the best magazine cover of the year, you have just won it hands down with the cover of the January 2018 issue. Thanks for a great laugh plus some good information. It's hard to write this and not laugh about being “sick as a dog.”
—Constantine Tgiros, Macomb, MI

I JUST RECEIVED the January issue and am puzzled as to why in all the cold and flu medications you recommend (“How to Survive Cold & Flu Season”), you never mention aspirin. I've used aspirin all of my life for fever and minor aches and have always found relief. Why have you discounted its use for cold and flu?
—Lawrence Kilbert, Tucson, AZ

EDITOR'S NOTE *Aspirin can help ease the pain or fever from a cold or the flu. But you usually need a large dose—two 325-mg tablets every 4 hours—to get that benefit. (That compares with the 81-mg dose, or “baby” aspirin, that some people take to help prevent heart attacks and strokes.) That higher dose increases the risk of internal bleeding, especially if you take other drugs that can thin the blood, such as clopidogrel (Plavix and generic) and warfarin (Coumadin and generic). And it shouldn't be given to children recovering from respiratory infection because of the rare possibility of Reye's syndrome, a potentially fatal disease. So CR's medical advisers generally suggest using other drugs to ease the pain and fever of a cold or the flu, including acetaminophen (Tylenol and generic), ibuprofen (Advil and generic), and naproxen (Aleve and generic).*



WRITE

Go to [CR.org/lettertoeditor](https://www.consumerreports.org/lettertoeditor) to share your comments for publication.

Driven to Distraction

“DRIVING WHILE DISTRACTED” in the January 2018 issue was excellent. I have had some close calls with distracted drivers. I was amazed (or horrified) at a red light recently when I looked in the car next to me and saw that the driver had two devices attached to the steering wheel for his use while driving.

—William Greer, Parrish, FL

WHEN OUR GRANDSON started to drive two years ago, I told him to put his cell phone in the trunk before he got in the car so he would not be distracted by its ring. He kids me by saying “trunk it,” but it works.

—Marlyn Alkins, Warrington, PA

I CAN'T SUPPORT a cell-phone block when a car is moving because then a passenger couldn't use his phone—which could be vital in an emergency. I agree that a driver should not be talking or texting on a cell phone, but a passenger shouldn't be restricted from doing so.

—Matthew Harris, via CR.org

EDITOR'S NOTE Many smartphone apps or phone features that block calls and texts when an automobile is in motion are voluntary, and they can be applied solely to the driver's phone. Apple's new iOS 11 operating system for the iPhone, for example, senses car motion and asks whether the owner wants to activate the Do Not Disturb feature, which blocks texts and calls. If you are a passenger, you can simply opt out when you receive the prompt. (The same goes for the Android-based app called In-Traffic Reply.)

ROAD SIGNS, BILLBOARDS, cool cars, scenery. It's not just about cell phones or infotainment systems. It's about our willingness to focus on driving, instead of driving while we focus on everything else.

—Laurie M. Coppola, via Facebook

! SUBSCRIPTION SCAM ALERT

Readers should be on guard against offers of new Consumer Reports subscriptions or renewals from companies that are not authorized to offer subscriptions on our behalf. The ones we're aware of are Global Publication Processing, National Publishers Group, Pacific Magazine Billing, Publisher Payment Center, and Atlantic Publishers Group, and there may be others.

Consumer Reports is taking action to address this problem. Meanwhile, you can spot unauthorized mailings because they may include the phrase “continuation/new order offer” (language CR never uses) or might not specify the subscription's expiration date. The back of the form states, “However, once we have processed your order a \$9.00 processing fee will apply plus our costs to submit your order.” CR never charges a processing fee.

Here's how to be sure a subscription or renewal mailing came from us:

- CR addresses your subscription status in its mailings by always providing your expiration date on our notices. (The date will match the one on your magazine label.)
- CR renewal payments require you to make your check payable to Consumer Reports.
- CR renewal orders are mailed to our Harlan, Iowa, or Markham, Ontario, address.
- CR does not charge cancellation fees.

To learn more go to CR.org/mailling0318.

Back to the Future

THE JANUARY 2018 edition of CR Insights highlights the intelligent high beams on the Lexus RX. My parents' 1970s Cadillac had an “electric eye” that would detect oncoming cars and switch the headlights from high beams to low. This was the car I learned to drive, and I found the automatic beam switch both reliable and convenient. It's always surprised me that it didn't become a standard feature on cars in the '80s, '90s, and beyond. When you're driving on a dark road it's always a little annoying to have to switch beams every time there is an oncoming car.

—Al Cinelli, Fair Oaks, CA

Straight Talk About Smartphones

IN “ARE YOU READY for Your Upgrade?” (January 2018), you note that a model passes your water-resistance test if it survives a dunk without being damaged. I'm a bicycle tourer and always have my Galaxy S8+ mounted on my handlebar. On recent trips, my phone got wet from rain. It was “undamaged” but when I needed to recharge it, I was warned by a message to disconnect the charger immediately as moisture had been detected. So my “undamaged” phone became inoperable, for quite a long time! At times when you're dependent on your phone, as I was, that can be disconcerting.

—Greg Veal, Akron, OH

EDITOR'S NOTE The Samsung Galaxy S8+ did pass our water-resistance tests, but like the majority of smartphones, it's true that you'll need to let it dry out before you can plug it in. That said, one solution might be to use a wireless charger, which will probably work when your charging cable doesn't. Either way, the good news is that, even if you need to wait for your device to dry, you won't need to worry about a phone damaged because of rain.

I JUST RECEIVED my January 2018 magazine, and when browsing the cell-phone ratings, I noticed there was no test on voice quality. What's the deal? I mean, we are talking about phones here, right? When shopping for a new cell phone, I select the one that has the best voice quality.

—William Martin, Odenton, MD

EDITOR'S NOTE You'll be happy to know that we do test for voice quality, and we factor it into each model's rating for calling. First, we evaluate what you hear and what's heard by other phones when you talk. Our tests are conducted in noisy and quiet environments. We also consider any step-saving functions for making and receiving calls that a phone offers, including hands-free capabilities such as voice command and Bluetooth, one-handed operation, speed dialing, ringer controls, and other features. And we look at keypad readability under different lighting conditions, and consider the ease and comfort of holding a phone while on a call.

CONNECT WITH US

f **FACEBOOK**
fb.com/consumerreports
fb.com/SomosCR

▶ **YOUTUBE**
[/consumerreports](https://youtube.com/consumerreports)

📷 **INSTAGRAM**
[@consumerreports](https://instagram.com/consumerreports)

🐦 **TWITTER**
[@consumerreports](https://twitter.com/consumerreports)
[@SomosCR](https://twitter.com/SomosCR)

📌 **PINTEREST**
[/consumerreports](https://pinterest.com/consumerreports)

in **LINKEDIN**
[/company/consumer-reports](https://linkedin.com/company/consumer-reports)

What We're Testing in Our Labs ...

In our 60 labs, we continually review and rate products. Here, timely picks for this month.

WiFi-Only Tablets

WE TESTED: 32 models

WE TEST FOR: Convenience, ease of use, display quality, versatility, performance, camera image quality, battery life, and more.

ABOUT THE SCORES:

Median: 71
Range: 59-84

Best Overall

Samsung Galaxy Tab S3 SM T820 (32GB, 9.7-inch screen)
\$600

84
OVERALL SCORE



Large Screen; Lots of Storage

Apple iPad Pro 12.9 (64GB, 12.9-inch screen)
\$800

80
OVERALL SCORE



Great Value

Amazon Fire HD 8 2017 (16GB, 8-inch screen)
\$80

72
OVERALL SCORE



Frying Pans

WE TESTED: 30 models

WE TEST FOR: Cooking evenness, how easily fried eggs slide off a nonstick surface, how durable a nonstick surface is over time, ease of cleaning, and more.

ABOUT THE SCORES:

Median: 60
Range: 31-87

Best Overall

Zwilling J.A. Henckels Energy Nonstick
\$100

87
OVERALL SCORE



Sizzling Hot Deal

Daily Chef (Sam's Club)
\$15

81
OVERALL SCORE



Best Cast Iron

Le Creuset Signature
\$150

52
OVERALL SCORE



Ask Our Experts

Is it true that I can clean a dirty cast-iron pan by putting it in the oven during its self-clean cycle?



“FOR THE GENERAL cleaning of a cast-iron pan, it’s overkill to put your pan in the oven during a self-clean cycle,” says Cindy Fisher, CR’s cookware tester. Further, many manufacturers of cast-iron pans don’t recommend it. “The high heat melts the seasoning [the oil baked into a cast-iron pan to help form a slick surface and prevent rust] off the pan,” Mark Kelly, a representative for the cookware brand Lodge Cast Iron, told us. For everyday cleaning, rinse with water, or use a paper towel to wipe clean. “For tougher messes,” says Fisher, “add a little water to your pan and simmer for a minute.” Or try gently scrubbing with coarse salt and a splash of water, then wipe dry. For some of our frying pan picks, see above.

ILLUSTRATION: SERGE BLOCH

For even more ratings of these and other product categories, online subscribers can go to CR.org.

Toaster Ovens

WE TESTED: 34 models

WE TEST FOR: How evenly a model bakes a batch of muffins and a pizza, how evenly it browns toast, how well it broils, ease of use, and more.

ABOUT THE SCORES:

Median: 59
Range: 26-76

Best Broiler

Breville Smart Oven Pro BOV845BSS (11x19x16 inches)
\$270



76

OVERALL SCORE

Perfect for Pizza

DeLonghi Livenza Stainless EO 241250M (12x19x18 inches)
\$270



70

OVERALL SCORE

Sweet for Small Counters

Hamilton Beach Toaststation 22720 (8x16x9 inches)
\$40



63

OVERALL SCORE

Vinyl Flooring

WE TESTED: 14 products

WE TEST FOR: How well the material withstands dents, stains, scratches, and sunlight; how quickly surface wear is noticeable; and more. (Prices are per square foot.)

ABOUT THE SCORES:

Median: 67
Range: 40-94

Best Overall

Congoleum DuraCeramic Sierra Slate S174 Golden Greige
\$5.00



94

OVERALL SCORE

Scratch and Dent Resistant

Armstrong Luxe Plank Timber Bay Barnyard Gray A6861
\$5.50



93

OVERALL SCORE

A Price That'll Floor You

Shaw Matrix Regency Gunstock Oak LX90100706 (Lowe's)
\$2.00



79

OVERALL SCORE

Stick Vacuums

WE TESTED: 35 models

WE TEST FOR: How well it removes surface debris from a medium-pile carpet and tile flooring, how well it performs in edges and corners, and more. (Models weigh over 6 lbs.)

ABOUT THE SCORES:

Median: 78
Range: 49-91

Best Overall

Bissell Air Ram 1984, cordless (7.9 lb.)
\$200



91

OVERALL SCORE

Most Versatile

Shark IonFlex 2X DuoClean Ultra-Light Cordless IF251 (8.8 lb.)
\$450



84

OVERALL SCORE

Stick Steal

Dirt Devil Reach Max Plus BD22510PC, cordless (6.3 lb.)
\$130



79

OVERALL SCORE

All-in-One Inkjet Printers

WE TESTED: 91 models

WE TEST FOR: How crisply, clearly, and uniformly a model prints text in various styles and sizes; how quickly it can print five 8x11-inch pages of text; photo quality; and more.

ABOUT THE SCORES:

Median: 59
Range: 38-74

Best Overall

Epson Expression Premium XP-640
\$150



74

OVERALL SCORE

For Photo Fanatics

Brother MFC-J5920DW
\$295



67

OVERALL SCORE

Bargain Beauty

Canon Pixma MG3620
\$80



67

OVERALL SCORE

Note: We rate different products according to different testing protocols; as a result, Overall Scores of one product category are not comparable with another.

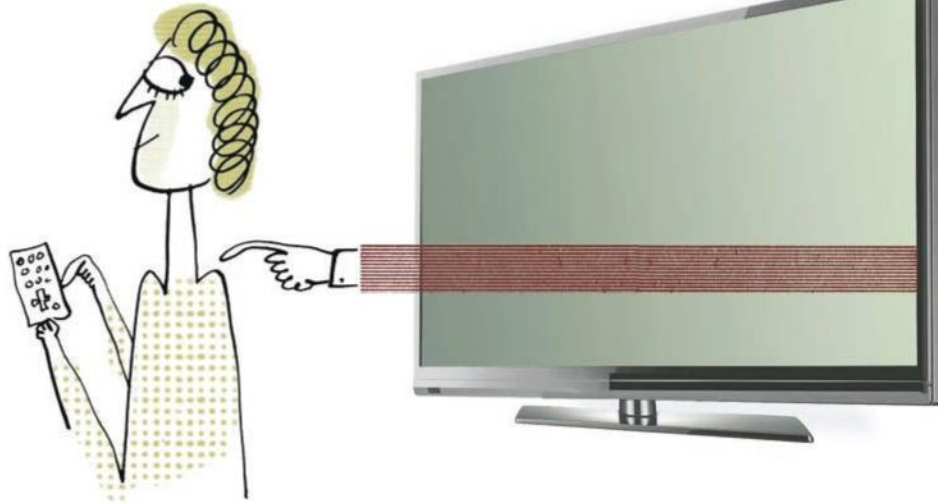

My TV prompts me to do updates, but I often ignore the requests. Is that bad?

We know you're busy—and there are exciting shows waiting in your streaming queue—but if you don't stop to upgrade every once in a while, you might run into a few problems. Usually there's a good reason your TV is asking you to approve an upgrade, says CR's TV and electronics tester, Claudio Ciacci. "It could be to improve security, fix a bug, give you new features, or make existing ones better."

By ignoring updates, you miss out on all of those free refinements. Sure, you'll have to do something else for a few minutes, but we think a secure, smoothly operating TV is worth the wait. Plus,

you'll save yourself many more minutes of aggravation that would have been spent dealing with issues that were already fixed by an update.

A tip for the upgrade-averse: Most smart TVs give you the option to enable automatic updates in your settings. While you're in there, check your picture adjustment, too. Occasionally an update may reset your display to the TV's default setting, but you can simply change it back to your preferred setup.

I wasn't able to get my flu shot earlier this season. Is it pointless to do so this late?

Not at all, says Marvin M. Lipman, M.D., Consumer Reports' chief medical adviser. In fact, in recent years the month of February has generally had the highest number of confirmed flu cases, according to the Centers for Disease Control and Prevention. What's more,

flu season can actually peak as late as March, and the viral illness can continue to circulate as late as May.

And note that although last year's shot for the 2016 to 2017 flu season was 39 percent effective at preventing flu overall, it was 52 percent effective against influenza B, which tends to be the strain more commonly reported during the end of the season.

Getting this year's vaccine may be most important for those who are at the greatest risk for complications—young children, adults age 50 and older, pregnant women, people with asthma or other lung disease—as well as for those who care for children and the elderly.

Another surprise: You should get the vaccine even if you've already had the flu this season. Why? There are usually several strains of the virus, and the vaccine could protect you against a strain that you didn't have—and could still get.

Though the vaccine is no guarantee that you won't get the flu, it will reduce your risk—and may also lead to a milder case if you do end up getting sick.

How likely am I to be audited? Are there any red flags I should know about?

"Less than 1 percent of individual tax returns are audited," says Tobie Stanger, CR's senior editor on the tax beat. However, you should be aware that your chances of being audited can increase if you take certain "gray area" deductions, such as home-office expenses, expenses related to a rental property you own, and charitable contributions.

You could also be inviting extra scrutiny if the income you report to the Internal Revenue Service differs from the income reported on a W-2 or 1099 MISC form, says Melanie Lauridsen, senior manager for tax advocacy at the American Institute of CPAs.

If you've been audited in the past, don't assume lightning will strike twice. Your chances of being audited again are not necessarily greater, unless you're a repeat offender—if, say, you repeat some of the same behaviors that triggered the first audit.

The best defense against an audit: Make sure you have adequate records that support your return, Stanger says, and that you or your accountant fully understands the nuance of the tax laws, especially with regard to your taxable activities for 2018, because much has changed.



We have more than 140 in-house experts who research, test, and compare! Submit your questions at CR.org/askourexperts ... and watch for the answers.

CR Insights

In the Know

Grills: The Fast and the Fiery



**Nexgrill
Deluxe**
720-0896B
\$400

69
OVERALL
SCORE

TOO MANY BACKYARD CHEFS start cooking soon after turning on the grill. But here's the rub: Most gas grills aren't ready in just a few minutes—at least not if you want to sear a steak at 500° F. "A gas grill should be preheated before you use it," says Cindy Fisher, CR's test engineer for grills. We fired up some popular grills to determine which get the hottest, fastest. Fisher collects data from temperature sensors that are placed evenly across a grill's grates, then uses the readings to map each grill's heat distribution exactly 10 minutes after turning the burner on high. As you can see from the maps shown below, some grills heat up faster, and more evenly, than others. "Some may take as long as 20 minutes to preheat, often because they have heavier grates—which isn't a bad thing," Fisher says.

**TEMPERATURES
AT 10 MINUTES**

- UNDER 400° F**
 Cooks slowly without defined grill marks.
- 400° TO 500° F**
 Hot enough to cook meat and fish.
- OVER 500° F**
 Hot enough to sear steak.

Monument
27592
\$340

65 OVERALL SCORE

✓ Weber
Genesis II LX
S-340 \$1,300

77 OVERALL SCORE

Napoleon
LEX485RSIB
\$1,150

64 OVERALL SCORE



Want to reduce the number of robocalls you receive (either on your cell or home phone) and minimize your chances of being fleeced? Follow our tips:

BLOCK 'EM

One of the best ways to reduce robocalls is to use blocking technology, which intercepts robocalls before they reach you. Some telephone companies offer robocall blocking services free of charge or for an added fee. Apps, such as Nomorobo, are free or cost just a dollar or two per month. If you have a copper landline, you may need to pay more than \$100 for blocking equipment, such as Call Control Home. Digital landlines often have free options.

DON'T KNOW THEM? DON'T ANSWER

A simple and effective way to avoid robocall scams is to not answer a call from any person or number you don't recognize on your caller ID. If the unknown caller leaves a message saying he or she is with a business or agency and you want to return the call, don't use the number that showed up on caller ID or that was left in the message. It could lead you back to a scammer misrepresenting himself. Instead, use the web or a telephone directory to find the number on your own.

DON'T ENGAGE

If you pick up a robocall, hang up immediately. Staying on the line (even to complain) or entering any numbers (even when instructed to do so to stop future calls) could lead to more calls in the future.

2.8 billion

That's how many robocalls—computer-generated calls— were sent to Americans in December 2017. Some are legitimate, such as surveys and political messages. But many are scammers using "spoofing" software to masquerade as a company or even a government agency.

Dishonest robocallers can pose as the Internal Revenue Service to trick unwitting consumers into paying taxes they don't really owe, or pretend to be the power company, threatening to turn off the lights unless a bogus overdue bill is paid. A growing number of robocallers are now showing up on caller ID with the same area code and prefix as the people they're targeting, as a way to increase the chances that a potential victim will pick up the phone.

ILLUSTRATIONS: CHRIS PHILPOT. PHOTO: FACING PAGE, TOP: GETTY IMAGES

CR Time Traveler MATTRESSES



1938 CR begins reviewing mattresses back when many cost \$20 to \$40. While innerspring technology is still new, many models are filled with cotton or horse hair. Few states have mattress regulations, so we warn that many are filled with "downright filthy" materials.

1954 As WWII production skills bring costs down on foam rubber beds, we test how firm they are with a compression machine. All demonstrated "exceptional durability."



1962 This wooden roller is used to test polyfoam mattresses. CU staffers also sleep on them: One had "the nervous impression that I was suspended by some sort of magic in mid-air."

Food Sleuth

What's in Your Coffee Cup?

FOR MANY OF US, a cup of joe is a happy—even necessary—morning ritual, and coffee itself has health benefits: Studies show it can lead to a longer life and lessen the risk of type 2 diabetes. But you can mess up a good thing with those little extras you stir in. If you drink two cups a day, for example, each with 2 ounces of cream and 2 teaspoons of sugar (32 calories), you'll take in about 300 calories and 24 grams of fat—slightly more than the number of calories and twice the fat of a jelly doughnut from Dunkin' Donuts.

The milk you choose can also make a big difference. (According to the Department of Agriculture, Americans bought more than twice as much 2 percent and whole milk as either 1 percent or nonfat in 2016.) A switch from, say, whole milk to 1 percent and less sugar can make a real impact on the calories you're consuming with your coffee. Simply look at our nutritional breakdown for guidance.



2 OUNCES OF	Soy Milk*	Nonfat Milk	1% Milk	2% Milk	Whole Milk	Half and Half	Cream
CALORIES	20	22	26	30	38	74	120
GRAMS OF FAT	1	0	0.5	1	2	6.5	12

*Unsweetened.

1997 With mattress shopping as opaque as ever, CR cuts models open to find out what's inside; our testing reveals that the number of coils doesn't matter as much as padding quality does.

1986 To test innerspring mattresses, we apply a "buttocks-shaped" ram 100,000 times, then see how they held up: Only six out of 32 sets had no structural damage.

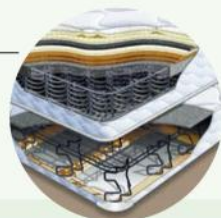

2005 California passes a fire safety law requiring a strict flammability test for mattresses. We report **Tempur-Pedic** and **Serta** are the only two national brands to immediately comply.



2014 Casper launches. It quickly becomes one of the best-known direct-to-consumer bed-in-a-box mattress brands, along with **Tuft & Needle** and **Leesa**, disrupting the mattress market at walk-in stores.

2018 Today, we still put mattresses through rigorous machine and human testing, including durability and firmness, and how well a mattress supports side and back sleepers. One of our CR Best Buys is below.

Denver Mattress Doctor's Choice
\$500

76 OVERALL SCORE



Product Spotlight

How to Pick a Lock

CONTRARY TO POPULAR belief, burglars very often break in during the day, entering through an open or unlocked door, according to Bureau of Justice Statistics. So to thwart thieves, always lock your door and install a high-quality lock—a good deadbolt that can withstand kick-ins and drill attacks.

We've discovered in our testing that many locks offer less security than you might expect. Our testers were

able to drill through most of the 17 locks we tested in just minutes.

Most locks use brass in the cylinder, which can be drilled through. The toughest “high security” locks, such as the Medeco below, are made of brass with hardened-steel inserts, and some reinforce the cylinder with hardened-steel plates—which take so long to drill through that thieves may give up and move on. But the biggest flaw our testers see is in the strike plate, the metal piece

that screws into the door frame and holds the bolt in place when the door is locked. To stand up to kick-ins, the bolt must slide into a sturdy, flat strike plate or a box strike (see illustration below); either should be secured with 3-inch screws that hold fast to the framing of the house. Yet about 70 percent of the locks we tested came with a flimsy strike plate and ¾-inch screws that catch only the doorjamb, making it too easy to kick in the door as the short screws tear out.

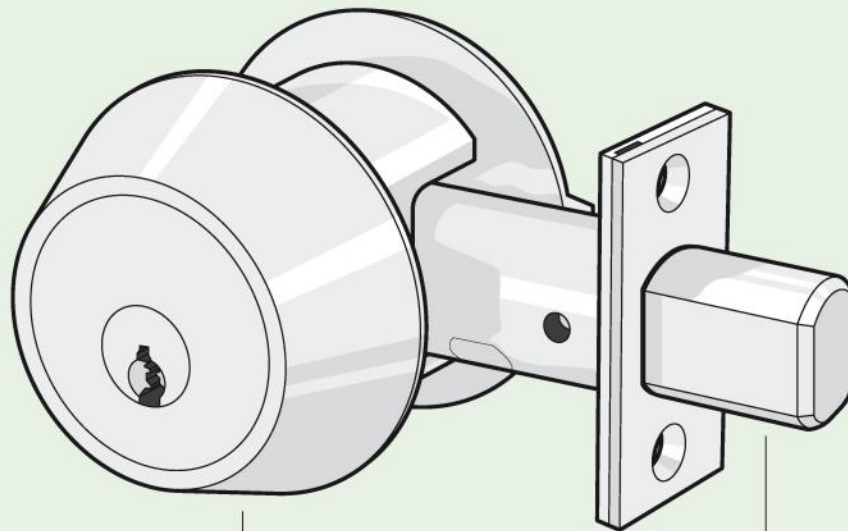

Drill-Resistant Cylinder
A cylinder made with hardened-steel inserts is the most difficult to drill through.

Beefy Bolt
Hardened-steel bolts are almost impossible to cut through with a reciprocating saw.

MAKE IT BETTER

Most locks we tested came with flimsy strike plates and ¾-inch screws. You can buy a box strike online for less than \$10, but we believe consumers shouldn't have to spend extra to make the deadbolt they purchased secure. Our challenge to lock manufacturers: Make heavy-duty hardware standard and provide 3-inch screws for locks.

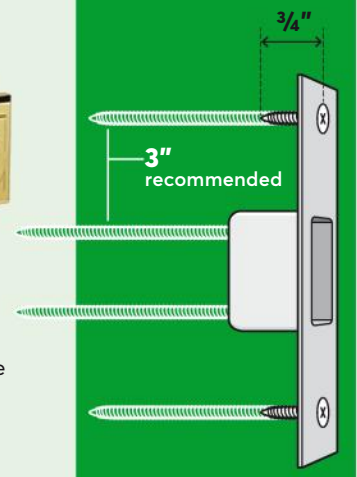

✓ **Medeco Maxum 11*603**
TYPE: HIGH-SECURITY
\$190



97

OVERALL SCORE

Our top-rated lock couldn't be picked by our pros and has a hardened cylinder we couldn't drill through. Plus it comes with a box strike and 3-inch-long screws. Changing the key requires a locksmith.

✓ **Kwikset 980**
TYPE: STANDARD
\$30



83

OVERALL SCORE

A terrific lock for the money. Our testers couldn't pick it, and it comes with a sturdy flat strike plate and long screws. And if you need to change the key for the lock, you can do it yourself, without a locksmith.

✓ **Baldwin Prestige 380**
TYPE: STANDARD
\$40



82

OVERALL SCORE

This traditional-looking lock comes with sufficiently long screws for the durable flat strike plate, which helped it stand up to CR's kick-in test. You can change the key yourself. And our experts couldn't pick it.

For a Rainy Day
The BMW 5 Series is one of several brands offering smart wipers.

82 OVERALL SCORE



HOW STUFF WORKS

Rain-Sensing Windshield Wipers

Ever wonder how your car knows it's raining—and even how hard? Most rain-sensing wipers use a sensor that's mounted behind the windshield. It sends out a beam of infrared light that, when water droplets are on the windshield, is reflected back at different angles. This tells the system to activate the wipers, as well as adjust wiper speed and frequency based on the intensity of the precipitation combined with the vehicle's speed. That's a real safety asset when driving through heavy rain on a dark highway. But our experts say there's room for improvement: It would be even better if the automatic headlights would turn on at the same time as the wipers, because many states require the lights to be on when the wipers are on. Still, it's a feature worth asking about when car shopping.



Still Confused By ...

Movie Downloads

GOING AWAY this spring? Depending on which airline you fly, some planes won't have individual seatback TV screens, so it's a good idea to come prepared with entertainment of your own. Luckily, some video streaming services let you download content to your tablet or phone ahead of time, which means no worrying about throttled data speeds or weak WiFi while traveling—you can just recline and click play. Here's how to do it on a few popular services:



Amazon Prime Video

This service, included with a \$99 Prime subscription, offers a bounty of popular downloadable titles, including films such as "Arrival" and "The Big Sick" and the original series "The Man in the High Castle." Compatible with Android, iOS, and most Fire Tablets, all you need to do is sign in and look for Prime titles that feature a "Download" option. You typically have 30 days to begin watching a video after you download it, and about 48 hours to finish watching a title once you start.

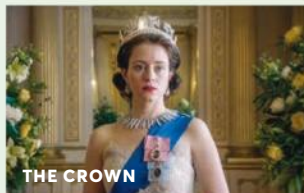

Netflix

The Netflix app allows subscribers to download some movies and series to mobile devices. These titles include original series, such as

"Narcos" and "The Crown," though the list updates frequently. You'll see a download button on the details page if a show can be downloaded. Monthly Netflix prices start at \$7.99.

YouTube Red

This service lets you watch videos without ads, which subscribers can download to view offline using an Android or iOS mobile app. It costs \$9.99 per month (\$14.99 for the family plan), but start with a free 30-day trial.



iTunes, Google Play, Vudu, and FandangoNOW

These are free to join and offer downloadable movies and TV shows that you can pay a modest price to buy or rent individually, then stream or download to your device using their respective apps. The typical rental period is 30 days, so you can rent and download, say, "Wonder Woman" from the Google Play store a few weeks ahead of a trip and not worry that it will expire by the time you press play on the plane.

Do More With ...

Your Instant Pot

IF YOU'RE THE proud new owner of an Instant Pot—or one of its more than 1.1 million Facebook community members—you're probably aware that this \$100 countertop appliance promises to tackle a wide variety of cooking tasks. But with seven different functions, you may not know where to begin. To help you tap into your Instant Pot's full potential, we tested the Instant Pot Duo DUO60's individual cooking modes—and pitted each one against a popular single-purpose competitor that performs the same task. Below are the four functions that we think Instant Pot performs just as well—or better—and you get all four in one machine.



1. Slow Cooker

The Instant Pot's slow-cooker function turned out pulled pork that was tender and delicious, says Bernie Deitrick, a CR test engineer. When compared with a Crock-Pot SCCPVL610-S Slow Cooker, \$55, the Instant Pot took a little longer, but we felt the minimal time difference wasn't critical—it is called

slow-cooking, after all. "Plus, it eats up a lot less storage space than all of the gadgets it replaces."

2. Pressure Cooker

Ready for ribs? The Instant Pot will deliver dinner in less than half the time your oven takes. It turned out juicy, tender baby back pork ribs in just 54 minutes,

making it just as good as (if not a teeny bit better than) the 6-quart T-Fal CY505E Electric Pressure Cooker, \$70, which took 56 minutes with similar results. "To finish off the ribs with a crispy crust, coat them in barbecue sauce and pop them in an oven set to 450° F for 15 minutes," Deitrick suggests.

3. Rice Cooker

"This little multitasking appliance is an excellent rice cooker," Deitrick says. In our lab, it cooked 2 cups of brown rice in 45 minutes—15 minutes faster than a \$30 Aroma ARC 914SBD Rice Cooker—and it tasted just as good.

4. Yogurt Maker

If you haven't tried

making yogurt in this pot yet, you should. Our testers made 128 ounces (a gallon) of plain yogurt. First, it heats the milk to 180° F, then lets it cool to below 115° F before you add yogurt starter. Fermentation takes about 8 hours. We found it to be just as tasty and well-made as in a Euro Cuisine YM100, \$40, which can make only up to 42-ounce batches.

PHOTO: JOHN WALSH/CONSUMER REPORTS

March Is

THE BEST TIME TO BUY ...



Space Heaters

As warmer weather inches closer, prices on heaters will begin to drop, so now is a good time to take one home for next winter.



Digital Cameras

At the end of this month, you're likely to see great prices—especially on older models—with deals second only to Black Friday sales.



CEILING FANS



Hunter is recalling about 168,000 Contempo ceiling fans because the owner's manual instructs users to install the light globe incorrectly, and the globe can fall, posing a risk of injury. The fans were sold at Costco stores and online from January 2016 through August 2017 for about \$130. Refurbished models were also sold online during the same period on Amazon, eBay, and Groupon.

What to do: Check to make sure the light globe was installed correctly by turning it clockwise until it stops and is resting firmly in place. Call Hunter at 866-326-2003 or go to hunterfan.com/recalls for more details.

DRINKING GLASSES



Libbey is recalling about 229,000 Bourbon Taster glasses because they can break during use and pose a risk of laceration. The glasses were sold at stores nationwide and online from May 2017 through October 2017 for \$20 to \$25 for a four-piece set, and \$6 per individual glass.

What to do: Stop using the glasses. Call Libbey at 800-982-7063 or return them to the place of purchase for a full refund.

KUBOTA UTILITY VEHICLES



Kubota is recalling about 26,900 RTV-X series utility vehicles because the seat belt stays can break and pose an injury hazard in the event of a crash. The vehicles were sold at Kubota dealers nationwide from June 2015 through June 2017 for \$15,000 to \$25,000.

What to do: Consumers should stop using the vehicle immediately and call Kubota at 800-752-0290 to schedule a free repair, or contact your authorized Kubota dealer.



▲ JOHN DEERE UTILITY VEHICLES

John Deere is recalling about 68,300 Crossover Gator utility vehicles (above) because the steering shaft can separate from the steering rack, resulting in a loss of steering control, which could cause the driver to crash.

What to do: Stop using the vehicle. Call 800-537-8233 or go to deere.com to contact your John Deere dealer for a free repair.

TABLE LAMPS



West Elm is recalling about 43,000 Industrial Task table lamps because the electrical wire that runs through them can be cut or frayed by the lamp's adjustable joint, posing a risk of electric shock. The lamps were sold at West Elm stores, in catalogs, and online from June 2014 through October 2017 for about \$130 for the lamp with a USB and \$80 to \$100 for the lamp without a USB.

What to do: Stop using the lamp and call West Elm at 866-577-9276 or go to westelm.com and click on "Safety Recalls" to arrange for a full refund.

PAIN RELIEVING CREAM



Natural Solutions for Life is recalling about 56,000 units of Maximum Strength Synodrin

Pain Relieving Cream with Lidocaine because the packaging is not child resistant as required by the Poison Prevention Packaging Act. The cream contains lidocaine, which poses a risk of poisoning for young children. The cream was sold at grocery stores and drugstores nationwide and online from June 2017 through October 2017 for about \$19.

What to do: Put the cream out of reach of all children. Call Natural Solutions for Life at 855-499-6435 or go to synodrin.com and click on "Recall Information" under "About Us" to get a free child-resistant lid.

CROSSBOWS



Ravin Crossbows is recalling about 220,000 arrow nocks because if the nock isn't fully engaged with the bowstring, the crossbow may not discharge when the trigger is pulled, which could lead to the bow discharging while re-nocking the arrow, posing a risk of injury. The nocks were sold at stores nationwide from October 2016 through November 2017 for \$8 to \$15 when sold separately (the nocks were also included as original equipment with Ravin crossbows and arrows).

What to do: Stop using the arrow nocks and call Ravin Crossbows at 888-298-6335 or go to ravincrossbows.com/safetyandinstructions to get free replacement nocks.

CHILDREN'S MATTRESSES



Dream On Me is recalling about 23,400 crib and toddler bed mattresses because they fail to meet the mandatory federal flammability standard, posing a fire hazard. The mattresses were sold online from January 2016 through December 2016 for \$40 to \$90.

What to do: Stop using the mattress and call Dream On Me at 877-201-4317 or go to dreamonme.com/customercare to get a free mattress cover for the mattress to meet federal standards.

DECORATIVE PUMPKINS



Pier 1 Imports is recalling about 16,600 glass pumpkins with wooden stems because the stem can detach when picked up, causing the glass base to fall and break, posing a laceration hazard. The pumpkins were sold at stores nationwide and online from June 2017 through November 2017 for about \$25 for a small-sized one and about \$30 for a medium-sized one.

What to do: Return the pumpkin to the nearest Pier 1 Imports store for a full refund or merchandise credit. Call Pier 1 Imports at 855-513-5140 or go to pier1.com and click on "Product Notes & Recalls" for more details.

POWER ADAPTERS



Netgear is recalling about 7,300 power adapters for outdoor Arlo cameras because water can leak into the weatherproof connector and cause a short circuit, melting, and overheating—posing a risk of fire. The adapters were sold at Fry's electronics stores nationwide, and online at frys.com and amazon.com from June 2017 through October 2017 for about \$20.

What to do: Stop using the adapter. Call Netgear at 866-243-0513 or go to arlo.com, then click on the tab at the top of the page for a full refund.

Product Updates

The latest ratings from our labs

The number of drones sold in the U.S. *

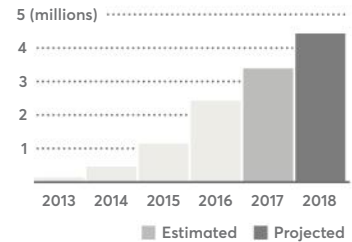

Taking Photos on the Fly

Aerial video of your daughter's wedding or a scenic hike is now within reach. Thanks to user-friendly design changes, drones are poised to go mainstream. CR puts the latest models to the test.

by Chris Raymond

ZeroTech
Dobby
\$280

67

OVERALL
SCORE

Palm Pilot

The ZeroTech Dobby and other handheld drones can be controlled with a smartphone.



FOR YEARS, AERIAL drones were beyond the reach of most consumers. They were just too expensive and hard to fly. And so the wonder of drone photography was left to aviation buffs and pro videographers who used the flying cameras to record weddings, real estate offerings, and adventure sports.

But with reliable, lightweight, and user-friendly models, all of that has changed. You can now purchase a drone recommended by Consumer Reports for as little as \$400 at Best Buy and capture video of a backyard barbecue or family road trip. Some even fold up and fit in your pocket.

“Four years ago, when I started flying, it was with people who enjoyed tinkering in the garage, building the things themselves,” says Sally French, founder of the Drone Girl blog. But new models put “drones into the hands of nearly everyone,” she says.

The Consumer Technology Association says U.S. consumers purchased 2.4 million recreational models in 2016. And it estimates that this year consumers will buy 4.4 million.

That intense growth has raised safety and privacy concerns for the general public as drone hobbyists increasingly zip their mini aircraft around suburban homes and parks. But a consensus is growing about what kinds of regulations, commonsense rules, and etiquette are needed to smooth the flight path for these flying cameras.

If you’re toying with buying a drone, be prepared to learn the technology and the rules—official and unofficial. Here’s a quick guide:

What Is a Drone?

The broad term can describe a \$20 remote control toy or a \$64.2 million armed spycraft flown by the U.S. Air

How to Shoot Great Drone Video

Consumer drones are essentially airborne video cameras, but flying and recording at the same time can be tricky. If you’re not careful, you can end up with shaky footage, excessive glare, or—worse—a run-in with a tree. Here are a few easy-to-follow tips:

FORM A FLIGHT PLAN. When you’re flying a drone, every minute counts, says Consumer Reports tester Alex Nasrallah. Don’t waste battery life thinking about what, where, and how to shoot—do all that in advance. To be extra prepared, create an equipment checklist, too, suggests Travis Jack, who produces video for clients. That way you won’t leave the controller at home charging in the kitchen when you dash off to capture that seaside sunrise.

STAY CLOSE TO EARTH. It’s tempting to fly as high as the drone can go, says blogger Sally French, but it’s far more interesting to capture the view from just above the rooftop. The best shots often materialize within 50 feet of the ground, but watch out for wires and other obstacles.

CONTINUED ON PAGE 20

Force. Some hobbyists buy specialized drones built for racing or acrobatics. The models Consumer Reports tested are essentially flying video cameras designed for mainstream use.

Priced between \$230 and \$900, they offer automated takeoff and landing features and preprogrammed modes that allow the craft to orbit you or follow you from above. Some can even return home using GPS.

The cameras take decent video (see “How to Shoot Great Drone Video,” at left), but not all models fly with the same precision and ease. And you might be surprised by the short battery life.

In our testing, the Parrot Bebop 2’s battery claimed top honors, delivering 24 minutes of flight time with the video camera running. The GoPro Karma logged 13 minutes. (GoPro announced recently that it’s exiting the drone business.)

Do I Need a License to Fly One?

No, as long as you’re flying for fun, and not financial gain. But you do have to register any drone that weighs between 0.55 and 55 pounds with the Federal Aviation Administration (FAA). The registration, good for three years, costs \$5 per aircraft and takes only a few minutes on the agency’s website.

Are Drones Dangerous?

They can be. Many models have guards that shield fingers from rotors and also come with low-battery warnings to alert the operator to land the drone before it falls from the sky. The Consumer Product Safety Commission doesn’t have the authority to set safety standards or oversee recalls for aircraft. And the FAA, for its part, generally provides guidance for where recreational drones can be flown.

Last November, Consumers Union, the policy and mobilization division of Consumer Reports, wrote to members of Congress to request greater oversight—even from the FAA—to better ensure that drones are built to be safe.

Hazardous crashes are fairly routine, especially among inexperienced pilots. A drone that drifts out of view can hurt bystanders and personal property.

Drones also can threaten larger aircraft. According to FAA computer simulations, a high-speed collision with a passenger jet could damage the jet's engines, stabilizers, or wings.

That's why the FAA requires drone pilots to notify airports before flying within 5 miles of such facilities. (For more restrictions, see below.)

How Hard Are They to Fly?

Flying a drone for a living teaches you to see the world differently, says Travis Jack, who runs Flyboy Photo & Media with wife Megan in Raleigh, N.C. You begin to notice tree branches, power lines, light poles, and all sorts of hazards looming overhead, he says.

Today's drones are designed with automated flying features and built-in safeguards. But they're not foolproof. CR testers lost a \$400 DJI Spark that zipped off on its own beyond the range of its controller—a mishap cited by other drone owners online. According to flight data saved in the cloud and reviewed later by the manufacturer, the problem was due to "a compass error of undetermined origin," which could mean "a faulty compass, failure to calibrate the compass before flight," or "electromagnetic interference."

It's a good idea to start out with a cheap model, says Los Angeles-based video producer Michael Kofsky, who has worked on projects for Consumer Reports. Kofsky learned to fly inside his home, weaving a \$90 drone in figure eights through the holiday decorations draped from his ceiling. "When I shelled out three grand for a drone, I had already crashed myself silly."

CONTINUED FROM PAGE 19

KEEP THE SUN AT YOUR BACK. This rule of earthbound photography applies to drones, too. Be wary of light bouncing off buildings and water. "You get a lot more reflection in the air," Jack says. Specialized lens filters, such as those from Polar Pro, can help cut the glare, he adds.

RISE UP. For a more dramatic shot, take a page from Hollywood and those classic crane shots and start recording at takeoff and keep going as the drone rises above the treetops. It's also a good way to limit crashes because it's less challenging to fly a drone upward than down, says Michael Kofsky, a videographer who occasionally shoots for CR.

GET A BIGGER SD CARD. Some drone cameras store video on microSD cards that you can pop out to retrieve the footage. (Many also let you transfer video wirelessly, through a phone app.) It's worth paying \$50 to upgrade from 16GB of storage to 256GB, Kofsky says. It's no fun landing to swap out a card.



BRING A SPOTTER. Once you hit record, you'll be looking down at your phone to see the live footage from the drone, says 16-year-old real estate photographer Ryan Felner. That's when the spotter—in Felner's case, his mom—looks to the sky to make sure his DJI Phantom 3 is not drifting into trouble.

Before your first flight, read the owner's manual and note maintenance procedures and pre-flight checklists.

Can I Fly in Parks?

The FAA says you must fly drones no higher than 400 feet and keep the craft in your line of sight at all times. Federal law also forbids drones from operating near wildfires (so that they don't endanger firefighters) and within three nautical miles of a stadium. National parks are mostly off-limits, and you can forget about buzzing landmarks like Mount Rushmore.

The FAA insists you steer clear of prisons, power plants, government buildings, and military bases. The rules vary by state and are often ambiguous.

"It's not like driving a car, where you more or less know what the rules are in every city," says French, the Drone Girl blog founder. For instance, some state parks allow drones as long as you don't disturb wildlife and fellow visitors.

Before you go flying, it's best to review local rules. The FAA has a free app named B4UFLY that uses GPS data to inform you of certain restrictions.

Regulations aside, it's smart to err on the side of caution. "At the end of the day, these are aircraft," says Gretchen West, a senior advisor in the Silicon Valley office of the law firm Hogan Lovells, which helps commercial clients navigate FAA regulations.

Can My Neighbors Use One to Spy on Me?

At the moment, federal privacy laws don't specifically address drones, but Peeping Tom laws may apply. And 2016 guidelines created by the National Telecommunications and Information Administration advise pilots not to fly over private property without permission. Bottom line: Drones are noisy and—like any video equipment—can seem intrusive. If someone objects to a drone, the operator should ground it and have a chat, West says. "It's best to cooperate and educate."

Ratings > **Top Flight** In our tests, we looked for drones with simple, reliable controls and high-quality cameras.

Do-It-Yourself Drone Shopping

Our tests confirm that it's possible to purchase a well-designed, user-friendly drone for just a few hundred dollars. The price ultimately depends on the features you choose.

Consider flight controls. There are two main ways to pilot a drone—through an app on your smartphone or tablet, or via a remote control unit (which may also integrate with your mobile device). A model that relies on a mobile app for maneuvering requires a Bluetooth or WiFi connection, which limits its

range to 260 feet or less (and only 164 feet vertically). If you want the freedom to fly the drone over large stretches of land or water, invest in a model with a remote control. It can pilot a drone from miles away.

When it comes to the camera, it's easy to get hung up on the image resolution. But the ultra high definition of 4K isn't worth it for most consumers. First, 4K drone cameras don't all deliver high image quality at that resolution. And when you post your flight video on YouTube, most of your friends are going to watch it in plain HD (aka 1080p) anyway.

Last, don't pay dramatically more to get safety features such as obstacle avoidance and return-to-home. They sound good but aren't always reliable. For instance, the return-home feature may let you down if the drone flies out of range or enters an area with poor satellite reception.

The tested drones, shown in the ratings charts below, fall into two groups: larger drones that generally have longer ranges and more features in the top chart, and smaller, shorter-range drones in the bottom one.

OUTDOOR ONLY

Rec.	Rank	Brand & Model	Overall Score	Price	Specs		Test Results					
					Weight (lb.)	Flight time (min.)	Flight	Image quality	Battery life	Versatility	Safety features	Ease of use
✓	1	DJI Mavic Pro	82	\$900	1.62	23	⬆️	⬆️	⬆️	⬆️	⬆️	⬆️
	2	Parrot Bebop 2 w/FPV pack	62	\$350	1.10	24	⬆️	⬆️	⬆️	⬆️	⬆️	⬆️
	3	GoPro Karma*	60	\$800	4.29	13	⬆️	⬆️	⬆️	⬆️	⬆️	⬆️
	4	Yuneec Q500+ Typhoon 4K Quadcopter	58	\$700	3.75	14	⬆️	⬆️	⬆️	⬆️	⬆️	⬆️

SELFIE DRONES

Rec.	Rank	Brand & Model	Overall Score	Price	Specs	Test Results						
						Weight (lb.)	Flight	4K video quality	HD video quality	Still photo	Battery life	Versatility
✓	1	DJI Spark	84	\$400	0.66	⬆️	NA	⬆️	⬆️	⬆️	⬆️	⬆️
	2	Yuneec Breeze 4K	68	\$230	0.85	⬆️	⬆️	⬆️	⬆️	⬆️	⬆️	⬆️
	3	ZeroTech Dobby	67	\$280	0.43	⬆️	NA	⬆️	⬆️	⬆️	⬆️	⬆️
	4	Xiro Xplorer Mini	62	\$500	0.96	⬆️	NA	⬆️	⬆️	⬆️	⬆️	⬆️
	5	Hover Camera Passport	54	\$500	0.53	⬆️	⬆️	⬆️	⬆️	⬆️	⬆️	⬆️
	6	Wingsland S6 4K	53	\$240	0.57	⬆️	⬆️	⬆️	⬆️	⬆️	⬆️	⬆️

HOW WE TEST: The scores for selfie drones should not be compared with scores for outdoor drones because we varied test protocols

to account for size, weight, and functionality. **Flight** reflects takeoff, landing, and maneuverability. **Battery life** was measured with

the drone hovering and recording video. **Versatility** rewards features such as folding rotors, orbit modes, and easy-to-replace batteries.

Safety features include prop guards, geo-fencing, obstacle avoidance sensors, and low-battery warnings.

*. Tested with GoPro Hero5 camera (sold separately). GoPro says it's exiting the drone business, so the model and replacement parts may be in limited supply.

Find the Best Mattress for You

End mattress madness once and for all by consulting our comprehensive ratings of 116 models and following our buying advice so that you can choose with confidence and pay a price that fits your budget. Plus, what you need to know about the booming bed-in-a-box option.

by **Mary H.J. Farrell**





We spend roughly a third of our life in bed.

The rest of it we spend shopping for the perfect mattress. Not really, of course. But that's how it can feel as we're traipsing from department store to bedding store to warehouse club, inspecting row upon row of identical-looking mattresses and fending off aggressive salespeople all claiming to offer the best deal. It's enough to make you hide under the covers. But a growing number of companies are taking the pain out of the buying process—no more showrooms or endless sales pitches—and promising a dreamy mattress at a competitive price.

The catch? You usually have to order online and the mattress arrives on your doorstep compressed into a box about the size of your coffee table.

“The idea of ordering a mattress online, the same way you make much smaller purchases, is still a novelty, even though it has been an option for several years,” says Claudette Ennis, the analyst who follows the mattress market for Consumer Reports. “Beds-in-a-box represent just a small part of the market today, but we've seen

some pretty remarkable growth in this category.” According to a report by the trade publication Furniture Today, direct-to-consumer mattress companies now command 12 percent of the market, up from 6 percent in 2014. Most beds-in-a-box are foam, but some manufacturers have found inventive ways to cram innerspring and adjustable air mattresses into cartons, too.

To make the process as pain-free as possible, many bed-in-a-box firms offer free shipping, and generous trial periods—usually 100 days, sometimes longer—and return policies. (Policies may differ if the mattress is purchased from a third-party retailer, such as Amazon.) Compare that with Macy's, where returns must be made within 60 days of purchase.

The success of major bed-in-a-box purveyors such as Casper, Leesa, and Tuft & Needle has inspired dozens of copycats. Industry sources report that the number of online mattress retailers is now approaching 200, and many are puffing up their marketing messages in

an attempt to be heard above the fray: “Goldilocks found the bed that's just right, and now you can too,” Purple touts. “The internet's most comfortable mattress,” Tuft & Needle declares. “Tirelessly engineered sleep products for your best rest,” Casper claims.

In short, they're promising to make your sleep dreams come true. Our rigorous, scientific testing and ratings will help you separate hype from reality and guide you to the choice that's best for you. CR tests innerspring, adjustable air, and foam mattresses—including 41 beds-in-a-box so far. (See “How We Test Mattresses,” on page 27, for testing details; see ratings on page 30.)

Here, the best way to purchase and set up a bed-in-a-box, as well as advice for buying traditional mattresses:

A Workaround for Comparison Shopping

One of the most frustrating things about buying a mattress has long been how difficult manufacturers make it to comparison shop. Unlike products that have the same name or model number no matter where they're sold (think a Samsung Family Hub refrigerator or a Vitamix blender), mattress makers often give the same model different names depending on where it's sold, making it almost impossible for a consumer to compare prices. (They might also make slight changes in construction or materials from one retailer to another.) So don't expect a salesperson to be able to guide you to a comparable model.

Bed-in-a-box sellers have eliminated this frustration from the buying process by paring down your choices. Many of these companies sell just one mattress, betting that it will suit most sleepers. Our testing shows that, in theory, at least, this approach can work.

“We've seen several bed-in-a-box mattresses come through the lab that perform consistently, at a level of Good

Continued on page 26 ➤

MATTRESSES THAT RISE AND SHINE

To help you narrow down the many mattress-buying options, we've selected eight high-scoring models from among the three types we test (foam, innerspring, and adjustable air) at a wide range of prices. (Prices listed are for queen-size mattresses.)

A Firm Lead



BED-IN-A-BOX

 **Sleep On Latex**

Pure Green Firm

\$1,200

81

This highly rated foam bed-in-a-box has an Overall Score that vies with some top conventional (and far more expensive) mattresses. And firm is right—this model scored a 7 out of 10 in our firmness test (with 10 being the firmest). It's a good choice for sleepers of all sizes and sleep styles, particularly if you sleep on your back.

WHERE TO BUY: sleeponlatex.com

Crowd-Pleaser



BED-IN-A-BOX

 **Casper**

The Casper

\$950

80

Casper's signature mattress delivers Very Good support for sleepers of all sizes and styles. The company recently released a more expensive model called The Wave, which performed similarly to The Casper in our tests, though it's softer and offers slightly less support for large and/or tall back sleepers. We think these minor differences make it tough to justify the higher price.

WHERE TO BUY: casper.com

The Price Is Right



BED-IN-A-BOX

 **Tuft & Needle**

T&N Mattress

\$575

74

The T&N Mattress ranks 13th out of the 53 foam models tested and will delight those for whom a low price is a high priority. In our support tests, it earned a score of Very Good for anyone who sleeps on his or her side but was only middling for average and large and/or tall back sleepers. In terms of firmness, it's middle-of-the-road.

WHERE TO BUY: tuftandneedle.com

Infinite Options



FOAM

 **Reverie** Dream Supreme II

Hybrid Sleep System Firm

\$3,500

81

Instead of coils, this mattress has 204 foam cylinders of varying densities that can be arranged in more than 37 trillion configurations. (The manufacturer provides instructions on how to place them to create a mattress that's firm, medium, or soft.) It received an Excellent score for durability. It's ideal for petite back sleepers and Very Good for sleepers of every other stripe. It's also very stable.

Top Innerspring



INNERSPRING

 **Charles P. Rogers**

Powercore Estate 5000

\$1,500

80

This top-scoring innerspring mattress in our tests excels at back support and is rated Excellent for back sleepers of every size and Very Good for all side sleepers. It has a high profile (14 inches), is durable, and is among the best we've seen at supporting the curve of the spine.

Stable Sleeper



INNERSPRING

 **Sealy Posturepedic**

Hybrid Elite Kelburn

\$1,350

79

Very Good for most side and back sleepers (though only Good for large and/or tall back sleepers), this mattress scored Excellent for durability and stabilization, so it will last a very long time without losing support and won't rock and roll when a fitful sleeper tosses and turns.

Mile-High Mattress



INNERSPRING

 **Denver Mattress**

Doctor's Choice

\$500

76

A softer mattress that scores equally well for back and side support, this model is extremely durable and has a surface that conforms to many body shapes. It's also fairly stable, enabling sleepers to easily change their sleeping position. All in all, a top performer at a pleasing price.

Air Apparent



ADJUSTABLE AIR

 **Sleep Number**

c2

\$900

81

An air mattress with adjustable firmness, this model provided superb support for most back sleepers and impressive support for side sleepers. It's breathable, which could reduce the likelihood of sleeping hot, and it showed no change after eight years of simulated use. The firmness level of each side can be adjusted independently.

to Excellent, for sleepers of every body size and sleeping style,” says test engineer Chris Regan, who oversees CR’s mattress tests. In fact, the top-rated foam beds-in-a-box score Very Good or Excellent in our support tests for petite, average, and large and/or tall sleepers.

Say Goodbye to ‘Try Before You Buy’

CR has long advised readers to lie on a mattress in the store for at least 10 to 15 minutes before buying. We still consider this critical: Our most recent mattress survey showed that the longer people try out a mattress before buying it, the more likely they are to be satisfied with their purchase. Ordering online eliminates this opportunity.

Certain companies have worked around this limitation by teaming up with walk-in retailers. For example, you can now try a Leesa mattress at West Elm and buy it there for the same price offered at leesa.com. Casper has twin-size mattresses on display at Target that you can curl up on for a foretaste of how they’ll perform.

A handful of the large bed-in-a-box companies have showrooms in large metropolitan areas, so if you’re interested in a different brand but you’re not ready to buy a mattress sight unseen, check the company’s website to see whether it has a showroom nearby. If it doesn’t, you can use our ratings, starting on page 30. Find your size and favorite sleep position, and note the models that provide adequate support for you—and for your sleeping partner.

Unlike mattresses sold at retail, which are usually marked up significantly and offer more price flexibility, bed-in-a-box mattresses are generally sold at a fixed price, making it difficult to haggle.

But there are other ways to save. Check the sellers’ websites for special offers such as a free pillow, and go to goodbed.com, which lists mattress

Do You Need a Box Spring?

A box spring, which serves as a foundation for a mattress, adds to the cost of new bedding, tempting many to do without one. Opinions vary on whether a box spring is really necessary. The International Sleep Products Association says the box spring is responsible for much of the comfort and support a mattress provides, but some mattress sellers say all that many of today’s models require is a sturdy surface, such as a platform bed.

Certain retailers press the issue harder than others. Casper, for example, recommends that buyers of its mattresses use Casper’s own foundation or bed frame. Lull says its mattress will work with everything from box springs to a slatted bed frame to the floor.

Our answer is always the same: Follow the manufacturer’s advice. “Some manufacturers’ warranties require that the mattress be placed on a matching box spring,” says Chris Regan, the engineer who oversees mattress testing at CR. “Not doing so will void the warranty.”

Skipping the box spring can certainly save you money in the short term, but it could cost you far more in the end.

discounts and coupons with savings of \$50 and up. Plenty of bed-in-a-box firms offer discounts around the same holidays that traditional retailers do—Presidents Day, Labor Day, and Black Friday. Use a website’s customer-service chat feature to ask about upcoming promotions or discounts.

Making Your Mattress Feel at Home

Mattresses usually arrive a few days to a week after an order is placed. Although the cartons are compact (the queen-size Lull, for example, comes in a 19x19x43-inch box), they can be heavy, ranging from 60 to 150 pounds, and difficult for someone to wrangle alone.

Shipping is often free, but for an additional fee almost all of these companies offer white-glove delivery, similar to the services offered by a traditional retailer. Casper charges \$75 to \$100 to move the mattress into the bedroom and set it up, and an additional \$50 to remove the old one.

A bed-in-a-box, which is usually foam, is compressed and rolled or folded (or both) before shipping. Most manufacturers recommend unboxing a new mattress within a month or two after it’s delivered. If you’re setting it up yourself, follow the steps outlined by the manufacturer. If you bought a bed frame or platform, put that together first.

Because they can be heavy and unwieldy when fully open, always take the mattress to the bedroom while it’s still in the box, Regan says. “Once you take it out of the box, put it on your box spring or platform before removing the plastic.” (See “Do You Need a Box Spring?” at left.)

“Some will be wrapped in multiple layers of plastic; others have only one,” Regan says. “You can use scissors or a knife to open them, but take care not to puncture the mattress.”

Continued on page 28 ➤

HOW WE TEST MATTRESSES

CR's scientific testing employs man, woman, machine—and plenty of technology—to push the mattresses we rate to their limits. Here's a behind-the-scenes look at a few key tests we run.

► Durability

A mattress is an investment. In our durability test, a machine pushes and pulls a 308-pound wood roller across the mattress 30,000 times to predict how it will hold up. The test takes about 30 hours and simulates eight to 10 years of use. When the torture ends, we measure for changes in firmness, check for sagging, and inspect for damage. "For a mattress to earn an Excellent rating in durability, we'd see no evidence of damage, sagging, or change in support," says Chris Regan, the engineer who oversees mattress testing. "In the worst models, we see sagging of nearly 10 percent."



◀ Firmness

Not all claims mattress companies make about firmness are accurate. We determine our firmness score with a machine that measures deflection. Then we rank the results on a scale of 1 to 10, with 10 being the firmest.

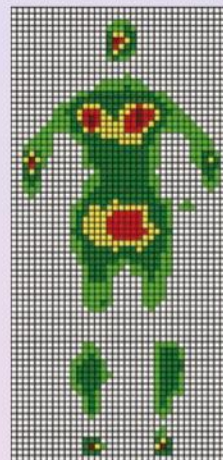

◀ Pressure

To measure pressure (a calculation that's factored into the Overall Score), we lay a mat equipped with 680 sensors over the mattress. A test subject then lies on his or her back, and the sensors record the level of pressure at almost every point where the body comes into contact with the mattress. In the resulting image, red indicates the points of highest pressure. "Those are the places where you might feel tingling, numbness, or even pain," Regan says. "The lower the pressure readings, the higher the score."

► Support

In our support tests, we use human subjects of small and large stature. (We average the results for average-sized sleepers.) For the side-sleeping score, we observe several points along each subject's spine and measure how much they diverge from a straight line. For a model to score well, the points must remain fairly parallel to the surface of the mattress. For the back-sleeper score, we graph dozens of points along the spine and measure whether the mattress maintains the spine's natural curve. —Haniya Rae



Once the wrapping is removed, the mattress regains the volume that was lost when compressed for shipment. It can take a few minutes to a few hours for the mattress to regain its full shape.

The materials in new mattresses can give off an odor, some of which is caused by the breakdown of volatile organic compounds in the foam. “More research is needed to determine whether or not there are any chronic health risks from long-term exposure to VOCs in mattresses,” says Don Huber, CR’s director of product safety. “The odor should dissipate in a few hours or, at most, a few days. You may want to wait until the odor goes away to sleep on your new mattress,” Huber says. Opening a window could help the odor dissipate more rapidly.

How to Have Many Happy Returns

As the old saying goes, you can’t put the genie back in the bottle. The same is true for beds-in-a-box. Return policies vary, but if you decide you don’t like your mattress during the trial period, you can usually get your money back. Fortunately, you won’t have to put the mattress back in the box.

Some sellers provide a full refund but don’t want the mattress back. Instead, they’ll help you donate it to a charity or nonprofit in your area. Casper and Tuft & Needle say they will help you find a charity that will pick it up. If there is no group in your area that will take it, these companies and others will arrange for the mattress to be picked up.

Many bed-in-a-box companies observe similar trial periods of 100 days or more, but some, such as GhostBed and WinkBeds, require you to keep the mattress for at least 30 days before arranging a return.

In the end, only 7 percent of the beds-in-a-box that are purchased are returned, according to 1010data, a data analytics company. That’s more than the 2.2 percent returned at Mattress Firm but an indication that most consumers are pleased with their purchase.

In case you’re not one of them, be sure you understand the company’s return policy before you buy. And if you have the space and really want to be on the safe side, hang on to your old mattress until you’re sure that you’re going to stick with your new one.

Smart In-Store Shopping Strategies

Not ready to order a mattress online? Our expert buying advice will help consumers who prefer to shop for a mattress the traditional way—in a store. CR’s years of testing have shown that, whichever type you choose, you don’t have to spend much more than \$1,000 for a comfortable, supportive mattress, and you can certainly spend a lot less. See page 32 for full results of our mattress tests before you head out to the showrooms.

Understand Model Musical Chairs

If you find a mattress you like at one store and look for it at another retailer, you’ll probably be steered toward a model made by the same brand but with a different name. The salesperson might say that it has identical construction, but that’s probably not the case. Manufacturers offer certain model lines across the board, but they often create exclusive models to sell through major chains such as Macy’s, Mattress Firm, and Sears. That can make comparison shopping a challenge. Use our ratings as a guide, and ask for the precise model when you shop.

Make Your Decision Lying Down

The biggest benefit of shopping at a store is that you can try each mattress you’re considering. Wear loose clothes and shoes that you can slip off, and take your favorite pillow. Shoo away the salesperson if you’re feeling pressured. Spend at least 10 to 15 minutes in your favorite sleeping position(s). The more time you can spend, the more likely you’ll be satisfied with your purchase.

Check the Fine Print

Make sure the store offers a full refund or credit toward another mattress. Retailers’ return periods, sometimes called “comfort guarantees,” range from a couple of weeks to 120 days. Some, including Macy’s and Sears, charge a 15 percent restocking fee. Macy’s charges an \$85 pickup fee in addition to the restocking charge. Warranties range from 10 to 25 years and cover only manufacturing defects such as sagging and loose or broken coils. Coverage is frequently prorated, meaning that it decreases over time.

Try to Haggle

Once you’ve settled on a model, ask for a better price. Many businesses, such as warehouse clubs, have fixed prices and won’t budge. But for retailers that do negotiate, huge markups allow them to lower prices by 50 percent or more during sales. Our recommendation: Insist on a sale price you’ve seen for the mattress you want, and don’t be afraid to walk out. More than half the readers in our survey paid \$500 to \$1,750 for a mattress. Those who successfully haggled saved a median of \$205.

KNOW YOUR TYPE

There are three major mattress categories (our ratings, beginning on page 30, are divided into these types). This primer will help you make sense of their relative benefits and drawbacks.



Innerspring

More than 60 percent of mattresses sold today are innerspring models. Composed of steel coils in various configurations, they can also include layers of cushioning, such as a pillowtop; layers of standard foam; and layers of gel-infused foam, which manufacturers claim cools you down. (Our past tests have shown that innerspring mattresses containing gel do tend to sleep slightly cooler but that the reverse is true for gel-infused foam beds.) Shifting positions on a traditional innerspring mattress tends to be easy, but on certain models your partner might feel a bounce when you do so. (We measure this in our stabilization test.) In our 2017 mattress satisfaction survey of nearly 62,000 Consumer Reports subscribers, 65 percent of innerspring owners were highly satisfied with their mattress.

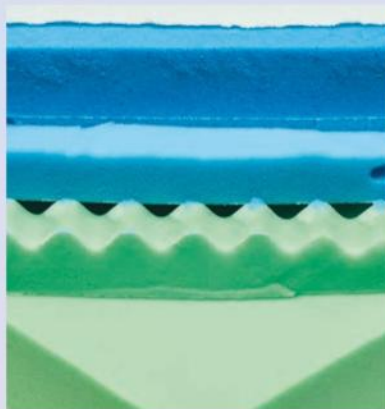

Foam

Foam mattresses, usually made of polyurethane or latex, vary widely in their construction. Many manufacturers use multiple layers of different types of foam, but our testing has shown no correlation between performance and the type of foam used. Memory foam, a temperature-sensitive variation that softens as it gets warmer, is well-regarded by those with health problems—such as back and joint pain—that affect sleep, according to our mattress satisfaction survey. Some owners feel that memory foam sleeps hot. We’ve found that any foam mattress can sleep hot because the material doesn’t allow for air to circulate in the same way an innerspring mattress does. Some find that it takes more effort to change positions on a foam mattress. Be sure to roll over and switch sides when you try out foam mattresses (and check our stabilization scores). Seventy-five percent of surveyed CR subscribers who own a foam mattress were highly satisfied with it.



Adjustable Air

This niche category of mattress is dominated by the Sleep Number brand. These are usually topped with layers of foam (so they share certain qualities of foam mattresses) and can be inflated by an electric pump to any firmness you desire at the push of a button. In fact, on most models, each half can be inflated to a different firmness level, allowing each sleeper to customize his or her side when two people share a bed. Eighty percent of surveyed CR subscribers who own an adjustable air mattress reported that they were highly satisfied with it. And folks with health problems that affect their sleep are even more likely to be highly satisfied with an adjustable air mattress than owners of foam mattresses are.

BEDS-IN-A-BOX

Like traditional mattresses, beds-in-a-box come in three types: adjustable air, foam, and innerspring. To make it easier for you to compare bed-in-a-box models with one another, we've consolidated the ratings of the 41 we've tested in this

chart. Most of the mattresses we tested scored Excellent or Very Good, and 12 foam models and one innerspring model earned the recommended designation. Note that the rank indicates

where these mattresses fall in the complete list of CR's mattress ratings, according to type, which is why there are gaps in the rank order. For full ratings of all mattresses, including these beds-in-a-box, turn to page 32.



Recommended	Rank	Brand & Model	Overall Score	Price	Test Results									
					Support						Durability	Stabilization	Firmness rating	
					Petite side sleeper	Average side sleeper	Large/tall side sleeper	Petite back sleeper	Average back sleeper	Large/tall back sleeper				
ADJUSTABLE AIR														
	3	Sleep Number It Bed ¹	60	\$1,100	↓	↓	↓	↓	↓	↓	↓	↑	↓	3
FOAM														
✓	1	Essentia Stratami ^{2,3,4}	81	\$2,445	↑	↑	↑	↑	↑	↑	↑	↑	↑	6
✓	3	Sleep on Latex Pure Green Firm ^{2,3,4}	81	\$1,200	↑	↑	↑	↑	↑	↑	↑	↑	↑	7
\$	4	Casper The Casper ⁵	80	\$950	↑	↑	↑	↑	↑	↑	↑	↑	↑	5
✓	5	Casper The Wave ^{2,5}	80	\$1,850	↑	↑	↑	↑	↑	↓	↑	↑	↑	3
\$	6	Serta Luxury 12" Gel Memory Foam ^{5,6}	78	\$500	↑	↑	↑	↑	↑	↑	↑	↑	↑	7
\$	7	Lull The Lull ⁵	78	\$800	↑	↑	↓	↑	↑	↑	↑	↑	↑	6
✓	8	GhostBed GhostBed ^{2,5,6}	77	\$795	↑	↑	↑	↑	↑	↑	↑	↑	↑	7
✓	9	Sleep Innovations Marley ^{5,6}	77	\$430	↑	↑	↓	↑	↑	↑	↑	↑	↑	7
✓	10	Purple The Purple Bed ³	76	\$1,000	↑	↑	↓	↑	↑	↓	↑	↑	↑	3
✓	11	My Pillow 10" Mattress ^{5,6}	74	\$900	↑	↓	↓	↑	↑	↑	↑	↑	↑	6
✓	12	Ashley Sleep The Perfect 10 ^{5,6}	74	\$700	↑	↑	↓	↑	↑	↑	↑	↑	↑	4
\$	13	Tuft & Needle T&N Mattress ^{3,6}	74	\$575	↑	↑	↑	↑	↓	↓	↑	↑	↑	5
	16	Brentwood Home Sequoia Euro Top ^{5,6}	72	\$1,495	↑	↓	↓	↑	↑	↓	↑	↑	↑	5
	18	Bear Queen ⁶	71	\$850	↑	↑	↓	↑	↑	↓	↑	↑	↑	6
	21	Novosbed Memory Foam ⁵	69	\$1,100	↑	↓	↓	↑	↑	↓	↑	↓	↑	4
	23	Luxi The Luxi Soft ^{2,5}	69	\$1,100	↑	↑	↑	↓	↓	↑	↑	↑	↑	4
	24	Yogabed Luxury Foam Y10 ³	69	\$850	↑	↓	↓	↑	↑	↓	↑	↑	↑	6
	26	Novaform Altabella (Costco) ^{5,6}	69	\$1,300	↑	↑	↑	↓	↓	↓	↑	↓	↑	4
	27	Dromma Triple Layer ^{2,5,6}	69	\$850	↑	↑	↓	↑	↓	↓	↑	↑	↑	4
	28	Sleep Innovations Taylor 12 inch Gel Swirl ^{5,6}	68	\$470	↑	↑	↑	↑	↑	↓	↑	↓	↑	6
	29	Novaform Comfort Grande (Costco) ^{5,6}	68	\$600	↑	↑	↑	↑	↓	↓	↑	↑	↑	6

¹ Firmness displayed is an average value. ² Includes a latex-foam layer. ³ Made of foam but not memory foam. ⁴ Certified organic. ⁵ Memory foam. ⁶ Includes a layer of gel-infused foam. ⁷ Firm models are memory foam; medium-firm models have latex foam.

Recommended	Rank	Brand & Model	Overall Score	Price	Test Results								
					Support						Durability	Stabilization	Firmness rating
					Petite side sleeper	Average side sleeper	Large/tall side sleeper	Petite back sleeper	Average back sleeper	Large/tall back sleeper			
FOAM <i>Continued</i>													
	30	Wright 1.27 Luxury Memory Foam ^{5 6}	68	\$1,785									4
	31	Leesa Leesa Medium Firm ^{3 5}	68	\$890									5
	35	Brooklyn Bedding Queen Med. Firm ^{2 3}	65	\$750									4
	39	Luxi The Luxi Medium Firm ^{2 5}	64	\$1,000									3
	40	Spa Sensations Memory Foam SPA-1000Q ⁵	64	\$360									6
	41	Ikea Matrand ^{2 7}	63	\$400									6
	44	Cocoon by Sealy Cocoon Firm ⁵	61	\$850									6
	45	Dream Bed The Dream Original Mattress ²	61	\$830									5
	47	Casper The Essential ⁵	60	\$600									3
	49	Ara 100% Visco Memory Foam (Costco) ⁵	55	\$1,100									2
	50	Serta iComfort Blue 100 Gentle Firm ⁶	55	\$2,750									4
	52	Luxi The Luxi Firm ^{2 5}	54	\$1,000									3
INNERSPRING													
	4	Voila Hybrid ^{2 5}	77	\$1,200									6
	17	King Koil Grand Eurotop ⁶	72	\$560									5
	21	Sapira by Leesa Luxury ⁵	71	\$1,475									3
	30	Night Therapy Euro Box Top Spring	69	\$248									3
	47	My Green Mattress The Natural Escape ⁴	60	\$1,000									3
	57	Modern Sleep Pillowtop Hybrid ⁶	50	\$595									2
	58	Classic Brands Mercer Hybrid ⁶	49	\$440									2

HOW BOXED BEDS WERE BORN

Casper, which launched in 2014, gets a lot of the credit for creating the bed-in-a-box. But Bill Bradley, a machinist from Johnson City, Tenn., built a machine that could compress and roll foam mattresses to

a size small enough to fit in a shipping box years before that. He began selling boxed mattresses online in 2007, and he claims to be the first person to do so.

Bradley's business (see bedinabox.com)

didn't take a very big bite out of an industry still dominated by long-established players such as 1800mattress.com and Mattress Firm. It wasn't until several years later, when Casper and early competitors

came on to the scene—sometimes backed by millions in venture capital—that the idea really caught on and consumers began to consider a boxed mattress as a serious bedding option.

Ratings > **Bedding Down** Complete ratings of the adjustable air, foam, and innerspring mattresses we've tested (including beds-in-a-box), so you can see how each model stacks up against the rest.

Recommended	Rank	Brand & Model	Overall Score	Price	Test Results									
					Support						Durability	Stabilization	Firmness rating	Bed-in-a-box
					Petite side sleeper	Average side sleeper	Large/tall side sleeper	Petite back sleeper	Average back sleeper	Large/tall back sleeper				
ADJUSTABLE AIR														
✓	1	Sleep Number i8 bed ¹ ³	84	\$2,900	↑	↑	↑	↑	↑	↑	↑	↑	3	
💰	2	Sleep Number c2 bed ¹	81	\$900	↑	↑	↑	↑	↑	↑	↑	9		
	3	Sleep Number It Bed ¹	60	\$1,100	↓	↓	↓	↓	↓	↓	↓	3	•	
FOAM														
✓	1	Essentia Stratami ² ³ ⁴	81	\$2,445	↑	↑	↑	↑	↑	↑	↑	6	•	
✓	2	Reverie Dream Supreme II Hybrid Sleep System Firm ⁴	81	\$3,500	↑	↑	↑	↑	↑	↑	↑	4		
✓	3	Sleep on Latex Pure Green Firm ² ³ ⁴	81	\$1,200	↑	↑	↑	↑	↑	↑	↑	7	•	
💰	4	Casper The Casper ⁵	80	\$950	↑	↑	↑	↑	↑	↑	↑	5	•	
✓	5	Casper The Wave ² ⁵	80	\$1,850	↑	↑	↑	↑	↑	↓	↑	3	•	
💰	6	Serta Luxury 12" Gel Memory Foam ⁵ ⁶	78	\$500	↑	↑	↑	↑	↑	↑	↑	7	•	
💰	7	Lull The Lull ⁵	78	\$800	↑	↑	↓	↑	↑	↑	↑	6	•	
✓	8	GhostBed GhostBed ² ⁵ ⁶	77	\$795	↑	↑	↑	↑	↑	↑	↑	7	•	
✓	9	Sleep Innovations Marley ⁵ ⁶	77	\$430	↑	↑	↓	↑	↑	↑	↑	7	•	
✓	10	Purple The Purple Bed ³	76	\$1,000	↑	↑	↓	↑	↑	↓	↑	3	•	
✓	11	My Pillow 10" Mattress ⁵ ⁶	74	\$900	↑	↓	↓	↑	↑	↑	↑	6	•	
✓	12	Ashley Sleep The Perfect 10 ⁵ ⁶	74	\$700	↑	↑	↓	↑	↑	↑	↑	4	•	
💰	13	Tuft & Needle T&N Mattress ³ ⁶	74	\$575	↑	↑	↑	↑	↓	↓	↑	5	•	
✓	14	Serta iComfort Savant EverFeel ⁵ ⁶	74	\$1,575	↑	↓	↓	↑	↑	↑	↑	4		
✓	15	Reverie Dream Supreme II Hybrid Sleep System Medium ⁴	73	\$3,500	↑	↑	↑	↑	↓	↓	↑	3		
	16	Brentwood Home Sequoia Euro Top ⁵ ⁶	72	\$1,495	↑	↓	↓	↑	↑	↓	↑	5	•	
	17	Spring Air Back Supporter Natalie (Costco) ² ⁵	71	\$1,100	↑	↓	↓	↑	↑	↑	↓	7		
	18	Bear Queen ⁶	71	\$850	↑	↑	↓	↑	↑	↓	↑	6	•	
	19	OrganicPedic by OMI Flora Nouveau ² ³ ⁴	71	\$4,445	↓	↓	↓	↑	↓	↓	↑	4		
	20	Ikea Morgongava ² ³	70	\$1,000	↑	↓	↓	↑	↑	↑	↑	5		
	21	Novosbed Memory Foam ⁵	69	\$1,100	↑	↓	↓	↑	↑	↓	↑	4	•	
	22	Eight The Smart Mattress	69	\$1,050	↑	↑	↓	↑	↓	↓	↑	5		
	23	Luxi The Luxi Soft ² ⁵	69	\$1,100	↑	↑	↑	↓	↓	↑	↑	4	•	
	24	Yogabed Luxury Foam Y10 ³	69	\$850	↑	↓	↓	↑	↑	↓	↑	6	•	
	25	Reverie Dream Supreme II Hybrid Sleep System Soft ⁴	69	\$3,500	↑	↑	↑	↓	↓	↓	↑	3		
	26	Novaform Altabella (Costco) ⁵ ⁶	69	\$1,300	↑	↑	↑	↓	↓	↓	↑	4	•	
	27	Dromma Triple Layer ² ⁵ ⁶	69	\$850	↑	↑	↓	↑	↓	↓	↑	4	•	
	28	Sleep Innovations Taylor 12 inch Gel Swirl ⁵ ⁶	68	\$470	↑	↑	↑	↑	↑	↓	↑	6	•	

¹ Firmness displayed is an average value. ² Includes a latex-foam layer. ³ Made of foam but not memory foam. ⁴ Certified organic. ⁵ Memory foam. ⁶ Includes a layer of gel-infused foam. ⁷ Firm models are memory foam; medium-firm models have latex foam.

Recommended	Rank	Brand & Model	Overall Score	Price	Test Results									
					Support						Durability	Stabilization	Firmness rating	Bed-in-a-box
Petite side sleeper	Average side sleeper	Large/tall side sleeper	Petite back sleeper	Average back sleeper	Large/tall back sleeper									

FOAM *Continued*

29	Novaform Comfort Grande (Costco) ⁵ ⁶	68	\$600	↑	↑	↑	↑	↓	↓	↑	↑	6	•
30	Wright 1.27 Luxury Memory Foam ⁵ ⁶	68	\$1,785	↑	↑	↓	↑	↓	↓	↑	↑	4	•
31	Leesa Leesa Medium Firm ³ ⁵	68	\$890	↑	↑	↓	↑	↓	↓	↑	↑	5	•
32	Ikea Myrbacka ² ⁵ ⁷	68	\$500	↑	↓	↓	↑	↑	↓	↑	↑	7	
33	The Original Mattress Factory Serenity Latex ² ³	67	\$1,540	↑	↑	↑	↓	↓	↓	↑	↓	4	
34	Therapedic Eco-Gel2 Oceanfront ⁵ ⁶	66	\$2,500	↑	↑	↑	↓	↓	↓	↑	↓	2	
35	Brooklyn Bedding Queen Med. Firm ² ³	65	\$750	↑	↑	↓	↓	↓	↓	↑	↑	4	•
36	Amerisleep AS3 ³	65	\$1,200	↑	↑	↓	↑	↓	↓	↑	↑	3	
37	Tempur-Pedic Tempur-Contour Supreme ⁵ ⁶	64	\$2,200	↑	↓	↓	↓	↓	↓	↑	↓	2	
38	Sleep Science Escape	64	\$1,800	↑	↑	↓	↓	↓	↓	↑	↑	2	
39	Luxi The Luxi Medium Firm ² ⁵	64	\$1,000	↑	↑	↑	↓	↓	↓	↑	↑	3	•
40	Spa Sensations Memory Foam SPA-1000Q ⁵	64	\$360	↑	↓	↓	↑	↑	↓	↓	↓	6	•
41	Ikea Matrand ² ⁷	63	\$400	↑	↓	↓	↑	↓	↓	↑	↑	6	•
42	Dormeo 230GX ⁶	63	\$1,410	↓	↓	↓	↓	↓	↓	↑	↑	2	
43	Sealy Premium Collection Gratifying ⁶	62	\$1,850	↑	↑	↑	↓	↓	↓	↑	↑	2	
44	Cocoon by Sealy Cocoon Firm ⁵	61	\$850	↑	↓	↓	↑	↑	↓	↑	↓	6	•
45	Dream Bed The Dream Original Mattress ²	61	\$830	↑	↑	↓	↑	↓	↓	↑	↓	5	•
46	Loom & Leaf Luxury Relaxed Firm ⁴ ⁶	60	\$1,000	↑	↑	↑	↓	↓	↓	↑	↓	4	
47	Casper The Essential ⁵	60	\$600	↑	↑	↓	↑	↓	↓	↑	↓	3	•
48	Serta iComfort Savant III ⁶	56	\$1,775	↑	↓	↓	↓	↓	↓	↑	↑	2	
49	Ara 100% Visco Memory Foam (Costco) ⁵	55	\$1,100	↑	↑	↓	↓	↓	↓	↑	↓	2	•
50	Serta iComfort Blue 100 Gentle Firm ⁶	55	\$2,750	↓	↓	↓	↑	↓	↓	↑	↓	4	•
51	Palmpring Colva PP-4W-003Q ² ³ ⁴	54	\$3,400	↑	↑	↑	↑	↓	↓	↓	↓	8	
52	Luxi The Luxi Firm ² ⁵	54	\$1,000	↑	↑	↑	↓	↓	↓	↑	↑	3	•
53	Airweave Airfiber	51	\$1,300	↓	↓	↓	↑	↑	↑	↓	↓	10	

INNERSPRING

✓	1	Charles P. Rogers Powercore Estate 5000 ²	80	\$1,500	↑	↑	↑	↑	↑	↑	↑	6	
✓	2	Sealy Posturepedic Hybrid Elite Kelburn ⁶	79	\$1,350	↑	↑	↑	↑	↑	↓	↑	4	
✓	3	Stearns & Foster Lux Estate Middletown ⁶	78	\$2,300	↑	↑	↑	↑	↑	↑	↑	4	
✓	4	Voila Hybrid ² ⁵	77	\$1,200	↑	↑	↑	↑	↑	↑	↑	6	•
✓	5	WinkBeds The WinkBed	77	\$1,350	↑	↑	↑	↑	↓	↑	↑	5	
💰	6	Denver Mattress Doctor's Choice	76	\$500	↑	↑	↑	↑	↑	↑	↓	3	

Ratings > Bedding Down *Continued*

Recommended	Rank	Brand & Model	Overall Score	Price	Test Results								Firmness rating	Bed-in-a-box
					Support				Durability	Stabilization				
					Petite side sleeper	Average side sleeper	Large/tall side sleeper	Petite back sleeper			Average back sleeper	Large/tall back sleeper		
INNERSPRING <i>Continued</i>														
✓	7	Beautyrest Silver Golden Gate Pillowtop ⁶	75	\$1,130	↑	↑	↑	↓	↓	↓	↑	↑	4	
Ⓢ	8	Charles P. Rogers St. Regis Pillowtop	75	\$1,100	↑	↓	↓	↑	↑	↑	↑	↑	6	
✓	9	Sealy Posturepedic Performance Lawson Euro Pillowtop ⁶	75	\$1,570	↓	↓	↓	↑	↑	↑	↑	↑	6	
✓	10	Beautyrest Silver High Tide Luxury Firm Summit ⁶	75	\$1,355	↓	↓	↓	↑	↑	↓	↑	↑	2	
✓	11	Saatva Flagship Luxury Firm Eurotop	74	\$1,000	↓	↑	↑	↑	↑	↓	↑	↓	3	
✓	12	Ethan Allen EA Signature Firm ⁶	74	\$2,000	↑	↑	↑	↑	↑	↑	↑	↑	7	
✓	13	MacyBed Lux by Kingsdown ⁶	73	\$1,500	↑	↑	↑	↑	↓	↓	↑	↑	3	
✓	14	Stearns & Foster Signature Garrick Luxury ⁶	73	\$2,200	↑	↓	↓	↑	↑	↓	↑	↑	4	
✓	15	Duxiana Dux 1001	73	\$4,950	↑	↑	↑	↑	↑	↓	↑	↓	4	
	16	Tempur-Pedic Tempur-Flex Supreme Breeze ^{5,6}	72	\$3,500	↑	↑	↓	↑	↑	↓	↑	↑	4	
	17	King Koil Grand Eurotop ⁶	72	\$560	↑	↑	↑	↑	↑	↓	↑	↑	5	•
	18	Beautyrest Black Mariela	72	\$2,500	↓	↑	↑	↓	↓	↓	↑	↑	2	
	19	Beautyrest Silver Hybrid Grand Isle Firm ⁶	72	\$1,285	↑	↑	↓	↑	↑	↓	↑	↓	4	
	20	Beautyrest Silver Navy Pier Pillowtop ⁶	71	\$700	↑	↑	↑	↑	↓	↓	↑	↑	3	
	21	Sapira by Leesa Luxury ⁵	71	\$1,475	↑	↑	↓	↑	↑	↑	↑	↑	3	•
	22	Tempur-Pedic Tempur-Flex Prima Firm ⁵	71	\$2,100	↑	↓	↓	↑	↑	↓	↑	↑	4	
	23	Sealy Posturepedic Premier Hybrid Copper Cushion Firm ⁶	70	\$1,275	↑	↑	↑	↑	↑	↓	↑	↑	4	
	24	The Original Mattress Factory Orthopedic Luxury Firm	70	\$540	↑	↑	↑	↑	↑	↓	↓	↓	4	
	25	Kingsdown Passions Imagination ⁶	70	\$1,140	↑	↑	↑	↑	↓	↓	↑	↑	3	
	26	Beautyrest Legend McFarland ^{2,6}	69	\$1,950	↑	↑	↑	↑	↓	↓	↑	↑	4	
	27	Eastman House Lifetime Collection Eternity Euro Pillowtop	69	\$1,500	↑	↑	↑	↓	↓	↓	↑	↓	4	
	28	Sealy Posturepedic Performance Chase Pointe Eurotop ⁶	69	\$970	↑	↓	↓	↑	↑	↑	↑	↓	6	
	29	Bob-O-Pedic Hybrid Queen Cushion Firm ⁶	69	\$800	↓	↓	↑	↑	↓	↓	↑	↑	3	
	30	Night Therapy Euro Box Top Spring	69	\$248	↑	↑	↑	↓	↓	↓	↑	↑	3	•
	31	Charles P. Rogers Estate Nano ²	68	\$2,400	↑	↑	↓	↑	↑	↓	↑	↑	5	
	32	Beautyrest Black Hybrid Gladney ⁶	67	\$2,750	↑	↑	↑	↑	↓	↓	↑	↓	3	
	33	Intellibed Posture Perfect	67	\$3,800	↑	↑	↑	↑	↓	↓	↑	↓	3	
	34	Sealy Performance Dolby Cushion Firm ⁶	67	\$1,700	↓	↓	↓	↑	↑	↓	↑	↑	4	
	35	Spring Air Isabella	66	\$1,599	↑	↑	↑	↑	↑	↓	↑	↓	4	
	36	Tempur-Pedic Tempur-Flex Flex Supreme ^{5,6}	66	\$2,599	↑	↓	↓	↓	↓	↓	↑	↑	3	
	37	Saatva Luxury Firm Euro Pillowtop	66	\$900	↑	↑	↑	↑	↑	↓	↑	↓	3	
	38	Eclipse Comformatic Collection Diamond Plush ⁶	64	\$800	↓	↓	↓	↓	↓	↓	↑	↑	3	

¹ Firmness displayed is an average value. ² Includes a latex-foam layer. ³ Made of foam but not memory foam. ⁴ Certified organic. ⁵ Memory foam. ⁶ Includes a layer of gel-infused foam. ⁷ Firm models are memory foam; medium-firm models have latex foam.

Recommended	Rank	Brand & Model	Overall Score	Price	Test Results									
					Support					Durability	Stabilization	Firmness rating	Bed-in-a-box	
					Petite side sleeper	Average side sleeper	Large/tall side sleeper	Petite back sleeper	Average back sleeper					Large/tall back sleeper
INNERSPRING <i>Continued</i>														
	39	Denver Mattress Telluride	63	\$1,100	↑	↑	↓	↓	↓	↓	↑	↓	3	
	40	Ashley Sleep Anniversary Edition ⁶	63	\$600	↓	↓	↓	↑	↑	↓	↑	↑	5	
	41	Black Label Gel Queen Firm ^{2,6}	63	\$850	↑	↓	↓	↓	↓	↓	↑	↑	2	
	42	Hampton & Rhodes HR420S Plush	63	\$600	↓	↑	↑	↓	↓	↓	↑	↓	2	
	43	Serta iSeries Profiles Prominence Super Pillowtop ⁶	62	\$2,275	↓	↓	↑	↓	↓	↓	↑	↑	2	
	44	Shifman Handmade Original	61	\$3,500	↑	↑	↑	↑	↑	↑	↓	↓	8	
	45	Restonic ComfortCare Select Hampton ^{2,6}	61	\$1,500	↓	↑	↑	↓	↓	↓	↓	↑	3	
	46	Serta iComfort Applause II ⁶	61	\$1,155	↑	↑	↑	↓	↓	↓	↑	↑	3	
	47	My Green Mattress The Natural Escape ⁴	60	\$1,000	↑	↑	↑	↓	↓	↓	↑	↓	3	•
	48	Beautyrest Black Katarina Lux-Firm Pillowtop	59	\$2,350	↑	↑	↑	↓	↓	↓	↑	↑	2	
	49	Sealy Performance Kenney ⁶	59	\$700	↓	↓	↓	↑	↑	↓	↑	↓	5	
	50	Serta Perfect Sleeper Soothing Haven Pillowtop ⁶	58	\$1,775	↓	↓	↓	↓	↓	↓	↑	↑	2	
	51	Serta iComfort Expertise Super Pillowtop ⁶	58	\$1,775	↑	↑	↑	↓	↓	↓	↑	↑	2	
	52	Serta iComfort Hybrid Expertise Firm ⁶	55	\$1,775	↑	↑	↓	↓	↓	↓	↑	↑	3	
	53	Spring Air Back Supporter Perfect Balance Sophia	55	\$700	↓	↓	↑	↓	↓	↓	↑	↓	3	
	54	Hotel Collection Vitagenic Cushion Firm HL ²	53	\$2,800	↑	↓	↓	↓	↓	↓	↑	↑	2	
	55	Classic Brands Hybrid Gramercy ⁶	52	\$395	↑	↑	↑	↓	↓	↓	↑	↓	2	
	56	Ikea Holmsbu	52	\$800	↑	↑	↑	↓	↓	↓	↑	↑	2	
	57	Modern Sleep Pillowtop Hybrid ⁶	50	\$595	↑	↑	↓	↓	↓	↓	↑	↑	2	•
	58	Classic Brands Mercer Hybrid ⁶	49	\$440	↓	↓	↑	↓	↓	↓	↑	↑	2	•
	59	Serta iComfort Smart Support HB300Q ⁶	46	\$2,275	↓	↓	↓	↓	↓	↓	↑	↑	2	
	60	Ashley Sleep American Classic Plush Latex ²	46	\$1,500	↑	↓	↓	↓	↓	↓	↑	↑	2	

HOW WE TEST: We calculate the **Overall Score** primarily by evaluating a mattress's side and back support, durability, and stabilization. For adjustable air mattresses, we use an average of firmness levels. **Support** for side sleepers is the ability to keep a side sleeper's spine relatively horizontal.

Support for back sleepers is the ability to maintain the natural curve of a back sleeper's spine. In our support tests, we use a woman 4 feet 11½ inches to 5 feet 1½ inches tall and 110 to 127.5 pounds for the **Petite sleeper** scores, and a man 6 feet 2 inches to 6 feet 4 inches tall and 220 to 242 pounds for

the **Large/tall sleeper** scores. The **Average sleeper** is an average of the two sizes. **Durability** gauges a mattress's ability to keep its original shape, height, firmness, and support after a simulated eight to 10 years of use, including our passing a 308-pound roller over each mattress 30,000 times. A high score for

Stabilization indicates little or no bouncing or vibration transferred for innersprings, and ease of movement and changing positions for foam. We rate **Firmness** on a scale of 1 to 10, with 10 being the firmest. **Price** is approximate retail for a queen-size mattress without a box spring.

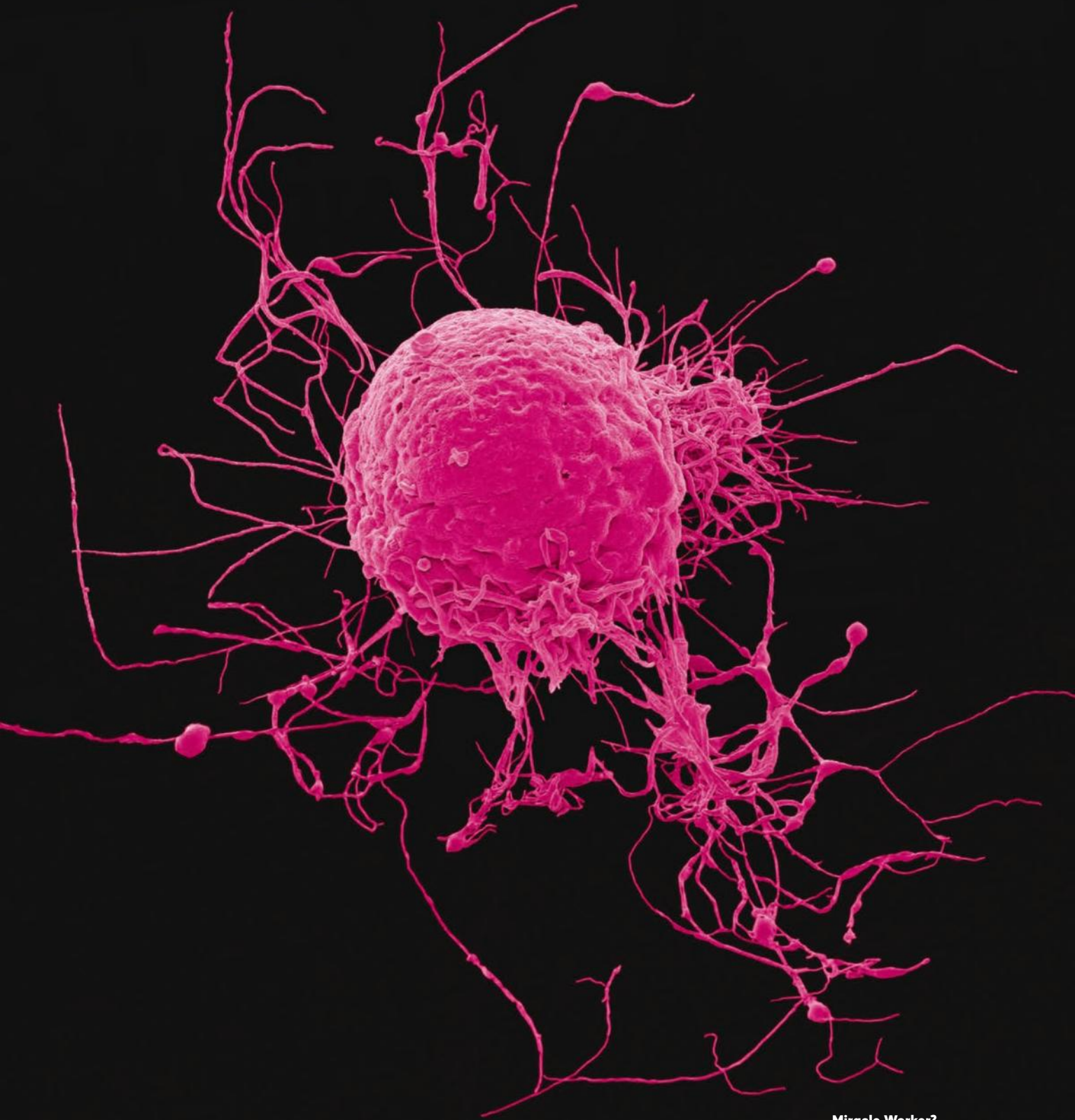

Miracle Worker?
Adult stem cells can help
treat only a short list of
diseases, such as leukemia.

Could This Cell Save Your Life?

STEM CELL THERAPY IS AN ACCEPTED TREATMENT FOR JUST A SHORT LIST OF MEDICAL CONDITIONS. AND YET SOME STEM CELL TREATMENTS ARE BEING PROFFERED FOR A WIDE RANGE OF ILLNESSES. THOSE TREATMENTS ARE OFTEN INEFFECTIVE AND SOMETIMES DANGEROUS. HERE'S WHAT YOU NEED TO KNOW TO STAY SAFE.

By Jeneen Interlandi

JOHN RODOLF SAYS it was the online sales pitch that helped persuade him to fork over \$6,000 to the Lung Institute in Tampa, Fla., in August 2015. The institute's website cited both scientific research and patient testimonials as proof that its simple but cutting-edge stem cell therapy could successfully treat chronic obstructive pulmonary disease (COPD), a condition that left Rodolf struggling to breathe for most of his waking hours. His own doctor had described the condition as incurable. But, Rodolf says, the website suggested that restoring his

ability to breathe could be as simple as extracting these special cells from his own blood and then delivering them back into his body through an IV.

What the institute didn't explain was that such treatments aren't supported by the balance of scientific evidence.

Doctors and scientists have made some small but impressive strides in using stem cells to treat some complicated diseases. But so far, lung disorders aren't on the list. Rodolf, who says he got no benefit from the treatments, has signed on to a lawsuit alleging that the

Lung Institute intentionally defrauded him and dozens of other patients. In retrospect, he says he wishes he had been more skeptical. “It was a bad call,” he says. “But I couldn’t breathe at the time, and when you can’t breathe you’ll try just about anything.”

The Lung Institute declined to be interviewed for this article, but a spokeswoman said by email that the clinic had treated thousands of patients and that many of them had indeed seen an improvement in their quality of life.

Scientists and federal regulators say that stories like Rodolf’s illustrate something they are increasingly worried about. As evidence of stem cell therapy’s potential grows, so does confusion over what this emerging medicine can and can’t do. And with few consumer protections in place, unscrupulous doctors are exploiting that confusion for profit. Across the country, clinics like the one Rodolf went to are promoting stem cell therapies for a long list of conditions, including joint injuries, sexual dysfunction, COPD, lupus, and diabetes. These treatments are rarely covered by insurance, and they can cost thousands of dollars. None of them have been proved to work. Some have proved to be dangerous.

“There’s an important difference between the stem cell treatments emerging from slow and careful study and the ones being sold for thousands of dollars without any evidence of safety or efficacy,” says Orly Avitzur, M.D., Consumer Reports’ medical director. “But that difference is not being made clear to consumers.”

A Medical Gray Zone

Stem cells are special cells with the potential to repair damaged tissue and organs. Stem cell therapy involves using these cells in injections and tissue transplants to heal injuries and treat disease.

That’s not as simple or straightforward as it might sound. There are several types of stem cells, and not all of them are possessed of equal power. Those that come from human embryos or are specially programmed in a laboratory can turn into any kind of cell—and in theory, repair any organ or tissue—in the human body. But according to the current scientific consensus, stem cells taken from fully developed tissues (what scientists often refer to as “adult stem cells”) can only turn into the type of tissue from which they came. The therapeutic potential of these adult cells is believed to be much more limited, because fat stem cells can only turn into fat, liver stem cells can only turn into liver, and so on.



“Stem cells have taken on this sort of mythic power in people’s minds. But there are real limits to what most of these cells can actually do.”

—SALLY TEMPLE, PH.D., SCIENTIST,
THE NEURAL STEM CELL INSTITUTE, RENSSELAER, N.Y.

Access to embryonic stem cells is federally monitored, but adult stem cells, which can be extracted from a patient’s own body, are subject to relatively few federal regulations. As a result, doctors have generally been allowed to use them to treat a wide range of conditions without demonstrating that they’re safe or effective.

In fact, stem cell treatments are widely accepted only for two broad medical indications: to help treat a handful of blood disorders—including leukemia and some forms of anemia—and in some cases to help burn victims. “Stem cells have taken on this sort of mythic power in people’s minds,” says Sally Temple, Ph.D., a scientist at the Neural Stem Cell Institute in Rensselaer, N.Y. “But there are real limits to what most of these cells can actually do.”

The FDA has acknowledged the problem of under-regulated stem cell medicine and says it is taking steps to strengthen its oversight of this burgeoning industry. Regulators have issued warning letters to numerous stem cell clinics for violating laboratory and manufacturing standards, and have ordered at least one company to stop selling stem cell-based products. In November it declared that going forward, agency approval would be required for some stem cell therapies (the way it is for prescription drugs) and that clinics where patients are harmed would be subject to enforcement actions, including increased inspections and possible product seizures.

Patient-safety advocates say those measures fall short of what’s needed to protect consumers. “Clinics and doctors need to be prevented from selling dangerous untested medicine before they harm people, not after,” says Lisa McGiffert, director of the Safe Patient Project at Consumers Union, the policy and mobilization division of Consumer Reports.

The FDA declined to make any of its representatives

available for an interview for this article. But a spokesperson said by email that the agency is working to balance consumer protection with medical innovation, and that it is hopeful that doctors and clinics will comply voluntarily with the new framework.

A Climate of Confusion

There's no shortage of opportunity for consumers like John Rodolf to encounter the promise and peril of experimental stem cell treatments. They are being studied by blue-chip medical centers like the Mayo Clinic, offered in the exam rooms of dermatologists and orthopedists, and advertised in newspapers and online by more than 500 stem cell specialty clinics.

The level of scientific vetting these treatments have been subjected to runs the gamut. Some have been carefully developed and sanctioned by the FDA; others haven't been formally studied but have some evidence to support their use. Others still are untested and dangerously unscientific.

It can be difficult to tell which of those categories any given stem cell therapy falls into, in part because websites and advertisements that promote bogus treatments can look just as professional and trustworthy as the ones that discuss legitimate clinical trials. "I found out about the Lung Institute in a magazine advertisement in my doctor's office," says Maureen Rosen, a 75-year-old resident of Ocala, Fla., who, like John Rodolf, paid the Lung Institute thousands of dollars for COPD treatments she says didn't work at all. "And it looked impressive to me. And when I went online, the website looked like any other website that you'd see for a hospital."

Another problem is that questionable treatments are sometimes advertised alongside promising ones. For example, according to court documents and a case study published in the *New England Journal of Medicine*, three women suffered serious vision impairment (one went completely blind) after participating in a study they found listed at clinicaltrials.gov, a website maintained by the National Institutes of Health (NIH). The site lists more than 1,000 stem cell-related clinical trials. Some of them have secured investigative new drug (IND) approval from the FDA, a process that can take

years of research and involves careful vetting of protocols for safety and close monitoring of patients, as a rule. But other trials listed on the site haven't completed those steps, and there's no easy way to tell the two groups apart.

The clinical trial that allegedly cost the three women their vision was administered at U.S. Stem Cell Clinic (USSCC) in Sunrise, Fla. It involved extracting stem cells from the women's belly fat and injecting them into their eyes to treat their macular degeneration. Researchers say the protocol violated basic safety principles—such as treating only one eye so that the other would be spared in the event of complications—and that it used a type of stem cell that hasn't demonstrated any potential for treating macular degeneration. "Fat stem cells can only turn into fat," says Temple of the Neural Stem Cell Institute. "There's no reason to think they would do anything for diseases of the eye." U.S. Stem Cell Clinic declined to be interviewed for this article.

The NIH recently added a disclaimer to its clinical trials home page, warning that not all of the listed studies

have been vetted by a federal agency. But critics say that notice isn't enough to protect consumers, many of whom are desperate for miracle cures. "Some clinics effectively use this site as a marketing tool," says Leigh Turner, Ph.D., a bioethicist at the University of Minnesota who has studied the stem cell industry. "They post studies there because it gives them an air of legitimacy, which in turn helps them attract patients."

An NIH spokeswoman told *Consumer Reports* that the government agency is considering additional measures to help consumers navigate the site better, but she didn't mention specifics.

Stem cell scientists and patient-safety advocates say that stem cell specialty clinics are the most likely to sell untested therapies to consumers or to disguise questionable treatments as legitimate clinical trials. But even such well-known and trusted institutions as the Mayo Clinic, the University of California, Davis and



"[Some institutions] use patient testimonials to promote treatments that have not been scientifically proven. They create the impression that even though it's experimental, it really works."

—LEIGH TURNER,
PH.D., BIOETHICIST,
UNIVERSITY OF
MINNESOTA

Northwestern University have been accused of stem cell overhype. Some doctors and bioethicists believe that web videos touting clinical research at all three institutions run afoul of medical ethics. “They’re using patient testimonials to promote treatments that have not been scientifically proven,” says Turner. “They create the impression that even though it’s experimental, it really works.”

Northwestern University didn’t respond to requests for comment. But a UC Davis spokesperson said that the intention of its video was for consumers to simply “learn more” about the school’s work. And a Mayo spokesperson reportedly told Health News Review (a nonprofit that subjects health media to peer review) that the web video was meant not as an advertisement for stem cell therapy but to showcase promising research.

Victor Khabie, M.D., chief of sports medicine at Northern Westchester Hospital in Mt. Kisco, N.Y., says that some private-practice physicians (often in sports medicine and dermatology) are also guilty of selling stem cell injections that may have no therapeutic benefit, but that they’re largely responding to patient demand. “People hear about professional athletes who swear these injections cured their muscle damage or resolved their joint pain, and they come in wanting the same treatments,” he says. “When done right, these particular injections are safe. But they’re also very expensive, and there hasn’t been enough research to say whether or not the effects are placebo effects.” (A placebo effect refers to the tendency of any medical treatment, even a sugar pill, to produce some benefit simply because the patient expects it to work.)

In Harm’s Way

The women who suffered vision impairment after being treated at USSCC in Florida aren’t the only patients to have allegedly been harmed by an experimental stem cell treatment. According to court papers filed by the Florida State Board of Medicine, at least one patient died after receiving stem cell injections to treat nerve damage from a Florida doctor whose license has since been revoked. And according to the *New England Journal of Medicine*, a Massachusetts man was completely paralyzed after stem cells injected into his spine to treat a stroke-related disability morphed into a tumor. The article suggested that known cases of patient harm may only be the tip of the iceberg. Owing to a lack of reporting requirements,



“People think that since the cells come from their own bodies, they must be safe. But oversight is so lax that there’s no way to even know what you’re being injected with half the time.”

—PAUL KNOEPFLER, PH.D., STEM CELL RESEARCHER,
UNIVERSITY OF CALIFORNIA, DAVIS

the paper’s authors wrote, adverse events associated with unproven stem cell treatments are probably much more common than is currently known.

Paul Knoepfler, Ph.D., a stem cell researcher and industry watchdog at the University of California, Davis—who was not involved in the research promoted in the school’s web video—says that consumers routinely underestimate the risks associated with stem cell injections. “People think that since the cells come from their own bodies, they must be safe,” he says. “But oversight is so lax that there’s no way to even know what you’re being injected with half the time.”

Last summer federal agents confiscated smallpox vaccines from StemImmune, a California company that specializes in stem cell-based immunotherapies for cancer. The company was mixing those vaccines with stem cells to create an experimental—and dangerous, the FDA says—cancer treatment. It was being used by doctors at the California Stem Cell Treatment Centers (CSCTC) in Rancho Mirage and Beverly Hills. StemImmune didn’t respond to a request for comment. But Mark Berman, M.D., a co-founder of CSCTC, disputed the implication that his clinics were exploiting cancer patients or putting them at risk. “We have real board-certified oncologists evaluate these patients,” he says. “And it was all free of charge.”

According to the FDA commissioner, Scott Gottlieb, M.D., shoddy stem cell medicine does more than imperil unwitting consumers; it also threatens to undermine real scientific progress being made. “Products that are reliably and carefully developed will be harder to advance if bad actors are able to make hollow claims and market unsafe science,” he said in an Aug. 28 press release announcing that the agency would be issuing a new framework for stem cell regulations.

That framework, released in November, indicates that at least some stem cell treatments (namely those derived from belly fat) will now need FDA approval. The International Society for Stem Cell Research has hailed the new measures as an important step toward better consumer protection.

But whether they will usher in any meaningful change remains to be seen. The FDA says it will give companies

and clinics three years to comply with the regulations, provided their treatments and techniques haven't been deemed a threat to patient safety. But the agency hasn't explained how—or even if—it will determine which doctors and clinics are putting consumers at risk. And it hasn't clarified what will happen to clinics that don't comply within the three-year time frame.

According to the guidelines, treatments injected directly into the bloodstream or central nervous system will be considered more dangerous than those injected into joints or skin. But in a press conference this past November, Peter Marks, M.D., Ph.D., director of the FDA's center for biologics evaluation and research, implied that punitive measures would be taken only after patient injuries or illnesses were reported.

"There are literally hundreds and hundreds of these clinics," he said. "We simply don't have the bandwidth to go after all of them at once. So the judgment here is to go after the ones where we have documented instances of harm."

In the meantime, John Rodolf and Maureen Rosen say that after many months of waiting for their stem cell treatments to kick in, they gave up and tried more conventional approaches. Rodolf says that losing weight has helped improve his breathing. And Rosen now pays \$48 a month to go to pulmonary rehab, where she gets physical therapy three times a week. Her breathing has improved enough that she can remove her oxygen tank for small portions of her day. "I wish someone had told me to try this first," she says. "It's a lot cheaper, and it actually works."

How to Protect Yourself

The Food and Drug Administration, the International Society for Stem Cell Research, and CR's medical experts advise you to be cautious when considering stem cell therapy.

BEWARE OF THE HYPE AND HEFTY FEES

Doctors testing stem cell treatments in carefully controlled clinical trials usually don't promote their offerings with big, flashy advertisements that promise dramatic improvements or total cures. They also don't charge a lot. There may be some minor fees for travel or other personal expenses, but the treatment itself should be free or low-cost to participants. "A large price tag—especially in the range of thousands of dollars—should be a major red flag," says Marvin M. Lipman, M.D., Consumer Reports' chief medical adviser.

So should any doctor claiming to treat a wide range of medical conditions, such as autism, arthritis, and erectile dysfunction, with the same therapy. Different organs and body systems require different expertise—and different medicine—to treat, which is why most doctors specialize.

ASK QUESTIONS

Any doctor who offers stem cell therapy should be able to explain where the cells will come from, what will be done to them before they're injected into your body, and how, exactly, they will resolve your illness or injury.

He or she should also be able to offer you proof of safety and efficacy, even for experimental treatments.

Don't settle for patient testimonials. Ask how many people the proposed therapy has been tested on (the more the better) and whether those tests were done in clinical trials or as individual case studies. (Randomized controlled trials, where people given a treatment are compared with a control group that wasn't, are best.) It's also important to find out what the outcomes were. (Ideally, side effects were minimal and significantly more people improved than did not.)

READ THE FINE PRINT

If the treatment is being offered as a clinical trial, make sure the trial has been vetted by the FDA, a process known as securing investigative new drug (IND) approval. The agency advises that you ask to see the actual approval letter to make sure it has been issued specifically for the treatment you're considering. Treatments that have cleared this hurdle are much more likely to be safe than those that have not.

You should also make sure that any informed consent document (an explanation of the experimental treatment that study participants are usually asked to sign) provides a clear description of the treatment being offered along with the risks, alternative options, and details about what to expect in the days and weeks after the procedure. It should not indemnify doctors or their institutions against liability for negligence.

Planning for a **Secure Retirement**

There's plenty of uncertainty today about whether you'll have enough money to stop working, and when—especially if that decision is not entirely yours. But many factors are completely under your control. Take these savvy steps, whether you're in your 50s, 60s, or 70s.

by **Penelope Wang**



In Your
50s



In Your
60s

RETIREMENT PLANNING has always been full of uncertainties: How much longer will you be able to work? How much savings will you have when you stop working? How many decades will that money need to last? But for anyone nearing retirement, or already there, the level of uncertainty has rarely been greater than it is right now.

Most significantly, Congress and the White House have been overhauling many rules that have a big impact on consumers generally and retirement savers in particular. One of the most

sweeping changes is the new tax law that will greatly limit deductions and other breaks. That could have a major impact on your taxable income.

Investing is also more challenging. After a nine-year bull run, the benchmark Standard & Poor's 500 stock index is at record highs, so returns are likely to be lower in the years ahead. "There's a growing risk of a market correction in the future," says David Blanchett, director of retirement research at Morningstar, an investment research firm.

Don't let these worries paralyze you.

"The most important thing people can do is control what is controllable," says Andrew Jamison, a certified financial planner with Main Avenue Financial Services in Beaverton, Ore. And the truth is, the things you can control—your day-to-day saving, investing, and planning decisions—are what's most critical to your retirement success.

Whether you are still working and plowing money into your 401(k), or enjoying your retirement now, here are smart strategies that will help ensure your financial security.



In Your
70s

Working and Saving

50 to Early 60s

On average, men claim retirement benefits at age 64.2 and women at 64, Social Security data show. For nearly half, retirement comes sooner than expected, often because of poor health or a layoff, according to a 2017 report by the Employee Benefit Research Institute. But nearly a third of retirees leave their job because they can afford to. To improve the odds that you can retire on your own schedule, follow these steps.

ASSESS YOUR ASSETS. Add up your retirement savings to see whether you're on track to meet your retirement goals. As a benchmark, at 50 years old someone seeking to retire at age 65 should have stashed away the equivalent of 5.2 times their household income in financial assets, according to financial adviser Charles Farrell, J.D., LL.M., author of "Your Money Ratios" (2010, Avery). So if you're 50 years old and earning \$100,000, having a \$520,000 portfolio would leave you in good shape. (This calculation assumes you'll be living on about 80 percent of your preretirement income, including Social Security benefits.) Use an online tool, such as the T. Rowe Price Retirement Income Calculator, to see how your savings stack up.

BOOST YOUR SAVINGS. If you're falling behind on savings but you're still working, ramp up now by making the most of tax-advantaged retirement plans. Max out your 401(k) if you can—you can stash away as much as \$18,500 in 2018; those 50 and older can put away

\$6,000 more in catch-up contributions.

Don't have an employer plan? Opt for an individual retirement account. You can save up to \$5,500 per year in an IRA, plus a \$1,000 catch-up contribution for those 50 and older. A traditional IRA lets you save pretax; a Roth IRA lets you put away after-tax dollars that grow tax-free. If you have any extra savings, put money in a taxable account.

Of course, saving more requires cutting back on your spending. But there's a double benefit to doing that, says certified financial planner Michael Kitces, director of wealth management at Pinnacle Advisory Group in Columbia, Md. By living a more frugal lifestyle, you not only free up savings but also won't need as much money to live on in retirement because your scaled-down spending has become your new normal. So consider downsizing your house now that the kids have moved out, or cook more at home rather than eating out. These savings will make reaching your retirement goals more doable.

CONSIDER YOUR LONGEVITY. If you need more incentive to save, think about how long your money will have to last in retirement—it could be two decades or longer. According to the Social Security Administration, the average 65-year-old man today is expected to live until 84.3, and a 65-year-old woman to 86.6. If you're a couple, one of you has a 47 percent

At 50
years old, someone seeking to retire at age 65 should have stashed away the equivalent of 5.2 times their household income in financial assets.

chance of living until age 90.

Of course, average life expectancies won't tell you much about any individual—that's impossible to predict with any accuracy. Still, you can get a rough idea by running numbers at livingto100.com. The calculator there factors in data about your health and lifestyle. Most financial advisers typically plan for a retirement that lasts until age 90 or 95, Kitces says.

UNDERSTAND YOUR SPENDING. Once you have a rough idea of how long your money will need to last, you can create a retirement budget. Start by tracking what you're spending now, using software such as Mint or YNAB. "Most people have no idea where their money is going," says Scott Cole, a certified financial planner in Birmingham, Ala., "so this process helps clarify."

With a budget in hand, you can think about ways that spending might shift in retirement. Many financial planners suggest you aim to replace 70 to 80 percent of your pre-retirement income, assuming that retirees usually spend less. But many people spend as much as they did before because of higher travel and entertainment expenses, especially in the early retirement years. Spending tends to drop off in the middle phase of retirement, only to rise in later years as healthcare expenses increase—a pattern that Morningstar's Blanchett calls the "retirement spending smile."

DESIGN YOUR RETIREMENT LIFE. "You need to understand that you are not just retiring from something but also retiring to something," Cole says. So take the time now to fine-tune your vision of retirement and share your ideas with your spouse to see whether you're on the same page. If you're dreaming of moving to a beach town, for example, test-drive that life in an extended vacation. And if you intend to volunteer or build a second career as a small-business person, join organizations or take courses in relevant topics so you can gain experience over the next few years.

THE UNEXPECTED RETIREMENT

4 steps to take if you stop working sooner than you planned

Maybe you planned on retiring at 65 or even a little later, then suddenly—pow!—life happens and you're out of work well before that. A 2017 survey by the Employee Benefits Research Institute found that 48 percent of people retire unexpectedly, often because of health problems, caregiving demands, or being laid off from a job.

An unexpected retirement is a double whammy: It derails your future savings ambitions and may force you to tap retirement funds sooner than planned. The first thing to do—after taking a deep breath—is to “figure out how to move forward by thoughtfully examining your entire financial picture,” says Bill Galvin, a certified financial planner with Capital Management Group of New York. These steps can help you secure your long-term future.

1 Make sure your insurance needs are covered.

If you're not yet 65 and eligible for Medicare, good health insurance is a must. A spouse's employer plan may offer your best option. Leaving a job enables you to sign up for COBRA coverage within the 60-day period after the so-called “qualifying event.” You can pay to stay on your workplace plan for 18 months, though in some cases that can be extended to as long as three years. (Check with your human resources rep.) Because COBRA premiums can be costly, examine plans at healthcare.gov to search for a better deal. Depending on your health and finances, a high-deductible policy might be an economical choice. Also, depending on your household earnings, you might qualify for a subsidy from the Affordable Care Act or for Medicaid,

depending on where you live.

If you have and want to continue life or disability insurance, find out whether your workplace's plans are “portable.” You'll have to pay the premiums, of course, but you avoid the risk of being denied coverage if you try to buy these on your own.

2 Decide what to do with your retirement accounts.

In your final weeks on the payroll, try to contribute as much as you can to your 401(k) or 403(b) to maximize the match from your employer, says Maryan Jaross, AAMS, a senior financial adviser in Boulder, Colo. The next big decision is whether to keep your savings in your workplace account, if that's an option. (Some employers might require you to roll it over.)

There are pros and cons to staying with a company plan. Reasons not to: The fees might be high; you prefer the convenience of having your entire nest egg in a single individual retirement account; or there might be tax advantages to moving funds into a Roth IRA. On the pro side: a little-known rule that permits people age 55 or older to make withdrawals from that workplace account without penalty in the event of a job loss. (You usually pay a 10 percent penalty if you withdraw money before age 59½—a cost you should avoid unless absolutely necessary.)

If you have a pension, you may have the choice of taking it as a lump sum or an annuity—a decision that depends entirely on your specific financial needs. Investigate whether you can take annuity payments before retirement age, which can be a helpful source of income. Because these decisions can be overwhelming, consider enlisting a fee-only financial planner to

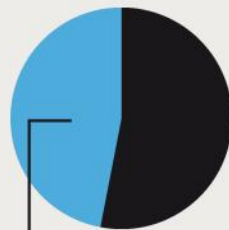

48% of people retire unexpectedly for reasons that include health problems, caregiving demands, and job layoffs.

help you. Find one through the National Association of Personal Financial Advisors at napfa.org.

3 Build a budget you can live with.

Create a spreadsheet or use an online budgeting tool (such as the one at bankrate.com; search for “home budget calculator”) to get a handle on your spending habits. Then examine your savings to figure out how much you can draw down each month. With an unexpected retirement, there will probably be a gap—though if you've been planning properly, it may not be as dire as you fear.

Still, you'll probably need to stretch your dollars, which can mean anything from eliminating extras (vacations, a second car) to making major lifestyle changes. Downsizing to a smaller home or a rental apartment or relocating to a

less expensive locale can have a big impact on your budget.

4 Identify new sources of income.

A home equity line of credit is a good source of emergency funds, but you'll need to apply for it when you're still employed; otherwise, you probably won't qualify. (Do this if you see a job loss on the horizon.) You may also be able to borrow from a whole life insurance policy, if you have one. Avoid relying on credit cards for expenses—this is not the time to go into debt. In the case of a layoff, be aggressive about negotiating the best possible severance package. And be sure to file for unemployment as soon as you can.

Finally, “Working should be a pillar of any retirement plan, so look for ways you can continue to earn income,” says Kerry Hannon, author of “Great Jobs for Everyone 50+” (2018, Wiley). If you've been laid off, finding another full-time job can be tough but not impossible, especially with today's low unemployment rate. But be realistic about your prospects: It might take a while to land something, and you probably will have to take a pay cut.

According to Hannon, the best way for older workers to job hunt is through personal referrals, so tell family, friends, neighbors, and former colleagues that you're looking for work. Also, check job listings at aarp.org/work, where you can find employers who have pledged to hire older workers, and sites such as Glassdoor, Indeed, and Monster. If your skills are out-of-date or you just want to do something new, investigate training programs at local colleges or check out websites such as Encore.org and iRelaunch.com.

—Mary C. Hickey

Easing Into Retirement

60 to Early 70s

As you close in on your retirement date, you have less time to recover from a financial setback. So make sure you have these bases covered.

STRESS-TEST YOUR FINANCES. How well would your retirement plan withstand a layoff or a market downturn? “It’s important to think ahead about your options,” says Anne Lester, head of retirement solutions at J.P. Morgan Asset Management. Run different scenarios on an online retirement calculator—using an earlier retirement date, lower returns, or the need to purchase health insurance prior to Medicare. A bad couple of years may not derail your finances if you can ratchet down your spending without giving up essentials. If not, you may want to work a year or two longer

to avoid an uncomfortable encounter with a worst-case scenario. “People underestimate what a powerful lever delaying retirement can be,” Lester says.

REVIEW YOUR SOCIAL SECURITY OPTIONS. There’s another reason to consider putting off retirement: By claiming Social Security later, you can receive more in benefits. Between ages 62 and 70, for each year you delay filing, your payment increases by 6.5 to 8 percent a year. If you can bridge your finances before claiming for even a year or two, it can be worth it. “There aren’t many other ways to get higher inflation-adjusted lifetime income,” says Sheri Conklin, a certified financial planner in Roseville, Calif.

Granted, not everyone can put off claiming Social Security, and the decision gets more complicated when you factor in a spouse’s benefits. So it can be smart to get help with this decision. One option is to use an online tool, such as the one at maximizmysocialsecurity.com (\$40 per year) or socialsecuritysolutions.com (\$50 for comparative reports), which provides customized advice. Or you may want to hire a financial adviser.

RESET YOUR PORTFOLIO RISK LEVEL. As you reach retirement, pay extra attention

to the amount you keep in cash or short-term bonds, vs. stocks. That’s to protect against what’s known as sequence of return risk: Poor stock returns early in retirement, combined with withdrawals to fund your expenses, raises the odds that you’ll dangerously deplete your portfolio. Even if returns recover, you may not have enough savings left to catch up.

To avoid panic selling, build up cash in taxable accounts that can cover your expenses for a year or longer, says Harold Evensky, a certified financial planner with Evensky & Katz/Foldes in Lubbock, Texas. A 2013 study by Evensky found that having those reserves raised the odds that a nest egg would be as much as 6 percentage points higher at the 30-year retirement mark vs. not having that cash on hand.

CHOOSE A SUSTAINABLE WITHDRAWAL RATE. When figuring out how much money you can safely pull from your portfolio, one common starting point is the 4 percent rule—in your first year of retirement, take out 4 percent of the initial amount, then increase that amount by inflation each year to make your money last at least 30 years. Today a more prudent starting point may be 3.5 percent.

HOW MUCH WILL YOU HAVE TO LIVE ON?

The rate at which you take income from your savings can determine whether your money will last your lifetime—or not. This chart shows withdrawals from two portfolios, one worth \$1 million and the other \$500,000, at different drawdown rates over 30 years.

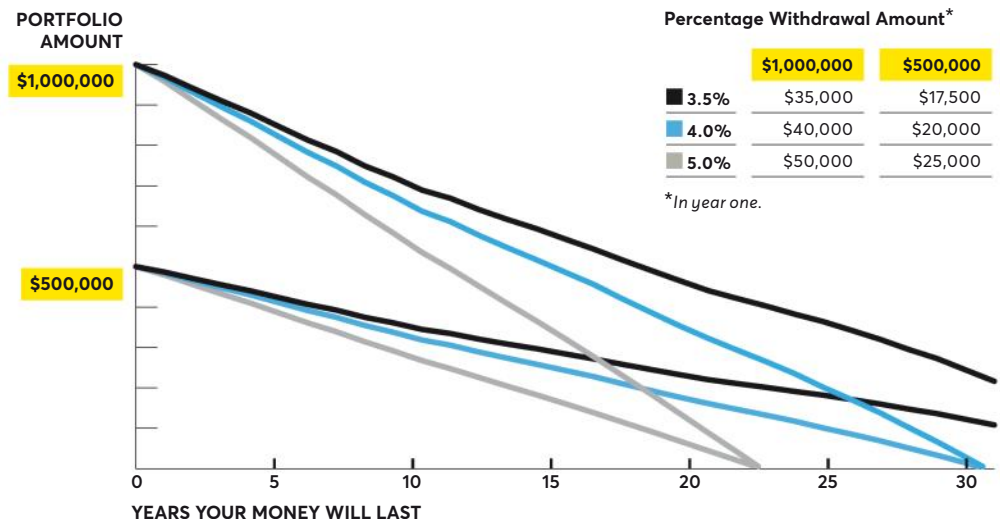

Note: Both portfolios are assumed to be composed of 40 percent equities and 60 percent bonds, and resulting projections are based on benchmark returns. The initial withdrawal is set at a fixed percentage of the initial amount and is then inflation-adjusted annually over the period at 2.5 percent. **Source:** David Blanchett, director of retirement research, Morningstar.

Living in Retirement

70 and Beyond

Once you're retired, your main concern will be making sure your retirement income keeps flowing, especially if your health expenses rise. A recent survey by the investment firm Capital Group found that more than 4 out of 10 retirees were spending more than they expected on healthcare.

MIND YOUR RMDs. Starting in the year you turn 70½, the clock begins ticking on the required minimum distributions you must take from your 401(k) and individual retirement accounts, which has to happen by the end of that year. (You can defer your first RMD until April 1 of the next year, but you'll have to take a second one before year-end.) Miss an RMD and you'll pay a 50 percent penalty and taxes on the money you should have withdrawn. Your RMD amounts are based on the market value of your accounts and your life expectancy (and that of your spouse if he or she is the sole beneficiary and more than 10 years younger than you). RMD percentages increase as you age. A single 70-year-old with a \$100,000 IRA portfolio, for example, would be required to withdraw \$3,650, and an 80-year-old would have to take out \$5,348. You can find RMD worksheets at irs.gov, and most brokerage firms will help you calculate the amounts.

SIMPLIFY YOUR FINANCES. Consolidating accounts at a single brokerage will make it easier to coordinate withdrawals, Kitces says. And your larger balance may qualify you for lower fees, which will boost your returns.

HOW TO AFFORD HEALTHCARE

Strategies to pay what may be your biggest retirement expense

Whether you're still saving for your later years or just joined the ranks of retirees, you're probably underestimating one major retirement expense: how much money you'll need to pay for your healthcare.

The numbers are big. A man retiring at 65 today with a typical lifespan will need \$189,687 (in today's dollars), on average, to pay healthcare costs not covered by insurance; a woman will need \$214,565, according to projections from HealthView Services, a healthcare cost data provider. And those estimates don't include the expense of long-term care if you have a chronic condition or disability.

One reason people get the number wrong is they think that Medicare, the government health insurance program for people 65 and older, will cover all their needs, says Ron Mastrogiovanni, HealthView's CEO. But Medicare isn't free. You pay premiums, deductibles, and co-pays. If you want coverage for prescription drugs, dental, vision, or hearing care, you have to pay out of pocket or buy a supplemental policy or additional insurance.

The good news is there is a lot you can do to manage the cost. Here, three ways to ensure your healthcare expenses are covered:

Create a healthcare investment account.

Once you have a handle on your expected healthcare costs, set up a dedicated account for healthcare savings separate from your other retirement money. Earmarking money for a specific goal makes it more likely that you'll be successful saving what you need, Mastrogiovanni says. You can use an individual retirement account. Or, if you have a high-deductible health plan (insurance with a deductible of at least \$1,350 per year for an individual or \$2,700 for a family), you can open a health savings account.

HSAs have a triple tax advantage: The money you contribute reduces your taxable income. If you spend the money on qualified healthcare expenses, you aren't taxed on it. And growth within the account is free from capital gains taxes. You can contribute up to \$3,450 as an individual or \$6,900 for a family annually, and an additional \$1,000 per year if you're age 55 or older.

Consider long-term-care insurance.

More than half of people who are 65 or older today will require long-term care at some point. A traditional long-term-care insurance policy can help cover the cost of home care, assisted living, or a nursing home. But it's expensive (averaging \$3,490 a year in premiums to cover \$150 a day in nursing home costs each for a 60-year-old couple), the policies can be confusing, and a number of companies offering plans have dropped out of the market. A less costly option is a short-term policy with more limited benefits. A 60-year-old might pay \$860 annually for a policy that provides \$120 a day for 360 days in a nursing home, plus \$900 a week for a year of home care, according to the American Association for Long-Term Care Insurance.

Take care of your health.

You'll have better quality of life if you maintain good health. But there's a financial benefit, too. Although your total medical costs rise the longer you live, your annual outlay is far less when you're fit: A person in poor health spends an average of about \$1,700 a year more on out-of-pocket medical expenses than someone in very good health, according to the Kaiser Family Foundation. Devoting less of your budget to health bills frees up money to spend on activities that make retirement more enjoyable. —Donna Rosato

**Physician
Assistant**

P.A.

**Registered
Nurse**

R.N.

**Medical
Doctor**

M.D.

**Nurse
Practitioner**

N.P.

**Doctor of
Osteopathic
Medicine**

D.O.

The

Will

Today it's getting harder to see an actual M.D. But you can still get **quality care from a host of other medical professionals** provided you know who's who. Plus, how to make the most out of your office visit.

by **Hallie Levine**

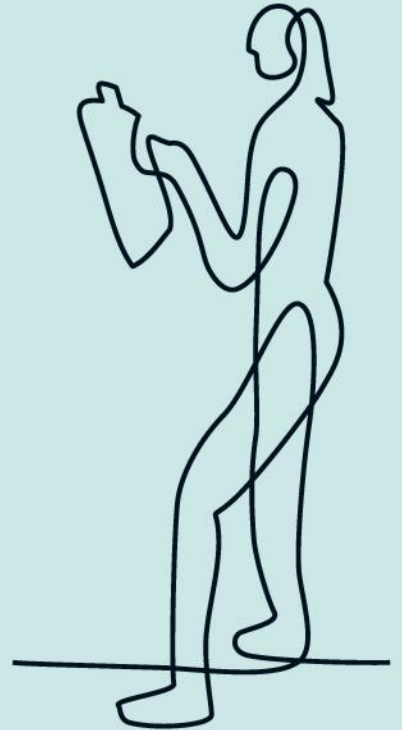

See You Now



used to be so simple:

You made an appointment with a doctor and would almost certainly see an M.D., someone who spent four years in medical school and then had at least three years of additional training, usually in a hospital.

But today you're likely to encounter a veritable alphabet soup of healthcare degrees: D.O., P.A., N.P., R.N., and N.D., to name a few. Who are all these people? What training do they have? Which one is best for you? And where's your good old M.D., anyway?

The truth is, you may not always need a traditional physician—and may have a difficult time finding one. The U.S. is short on doctors, especially those practicing primary care, who typically earn less than specialists. We now have fewer primary-care physicians per person than many other developed nations. Canada, for example, has 1.2 per 1,000 people; the U.S., just 0.3.

Fewer primary-care doctors means that it's harder to get an appointment. The average wait time for a new patient in a big city to see a family-medicine physician, for example, is now 29 days, compared with 19.5 days in 2014, according to the physician recruiting firm Merritt Hawkins.

At the same time, doctors today

are feeling pressure to work faster. Because of competitive forces in the marketplace, including many hospitals buying up physician practices, doctors are now more likely to work for large networks than for themselves. And those employers often set daily patient quotas—16 to 25 per day is typical—that can limit your time with a doctor.

That time crunch, combined with growing demands to document all of their encounters in often cumbersome electronic health records, is taking a toll on doctors.

More than half of primary-care doctors report feeling burned out, according to a 2017 Medscape survey. And that could undermine the care they provide, make them less willing to work collaboratively with patients, and drive even more out of the profession.

A TEAM OF PROVIDERS

Enter “advanced practice providers.” These are the N.P.s (nurse practitioners) and P.A.s (physician assistants) you may run into at a doctor's office.

They don't have as much training as M.D.s but are licensed to do many of the same things. And their ranks are growing fast. The share of physicians with these clinicians on their team has risen from 25 percent in 1999 to more than 60 percent now.

But is seeing one of them as good as seeing a medical doctor? In most cases, yes, says Ateev Mehrotra, M.D., an associate professor of healthcare policy at Harvard Medical School.

His January 2017 study in the journal *Medical Care* found that practices with more N.P.s and P.A.s had fewer specialist referrals, hospitalizations, and ER visits. And other research has found that when it comes to high blood pressure, diabetes, respiratory infections, and other common problems, there's little difference in treatment from M.D.s and advanced practice providers.

The team approach is also efficient, allowing each clinician to focus on what he or she does best. And it can mean shorter wait times and better patient education, according to a 2016 analysis by the Agency for Healthcare Research and Quality.

In addition to N.P.s and P.A.s, you may also be more likely to encounter other healthcare professionals now.

They include reputable ones, such as doctors of osteopathic medicine (D.O.). Their education is similar to an M.D.'s, with special training in muscle and skeletal issues, and their numbers have been growing.

But you may also encounter some more controversial providers, such as naturopathic doctors, or N.D.s.

This guide explains who's who, gives advice on how to get the most of your precious time with each of them, and identifies those you should consider steering clear of.



A Guide to Today's Healthcare Professionals

Everything you need to know about the providers you might see now.

FOR A ROUTINE office visit these days, you might not ever see an M.D. A case of the flu, for example, might be handled by a physician assistant (P.A.), and a regular checkup might be done mainly by a nurse practitioner (N.P.). And that can be just fine: Practices with advanced practice providers have outcomes at least as good as those that rely mainly on M.D.s.

But it can be reassuring to know exactly who it is you're seeing. Here's a guide to some of the providers and what sets them apart from one another.

Medical Doctor (M.D.)

TRAINING: Earning this degree requires four years of medical school—typically with two years studying biomedical science and basic clinical skills—and two more rotating through a broad variety of specialties. Then there's another three to seven years under the supervision of experienced faculty physicians.

STRENGTHS: M.D.s (and D.O.s; see right) have the most training of the providers you'll see. So if you have several conditions or symptoms that don't easily add up, an M.D. can connect the dots more easily, says David Blumenthal, M.D., president of the Commonwealth Fund, a nonprofit foundation that focuses on health policy.

LIMITATIONS: Primary-care docs are in short supply, so it might be difficult to find one accepting new patients, and he or she might not be able to spend as much time with you as you like.

CR'S ADVICE: If you have a complex health condition or one that isn't responding to treatment, you're better off seeing an M.D., says Marvin M. Lipman, M.D., CR's chief medical adviser. But if you're in good health or your condition is well-controlled, it can be fine to get the bulk of your care from an advanced practice provider.

Doctor of Osteopathic Medicine (D.O.)

TRAINING: The four years of medical education for D.O.s largely matches M.D. programs but also includes 200 hours in osteopathic manipulative medicine, hands-on techniques designed mainly to treat pain. These doctors participate in many of the same residency programs as M.D.s and can specialize in anything from pediatrics to psychiatry to surgery. One of four U.S. medical students now attends an osteopathic medical school. But don't confuse D.O.s with osteopathic practitioners who are trained abroad; they're neither M.D.s nor D.O.s., only perform manipulative treatment, and can't prescribe medicine.

STRENGTHS: "D.O.s are virtually interchangeable from M.D.s," says Susan Hingle, M.D., chair of the Board of Regents of the American College of Physicians. They provide a full range of medical care for all types of diseases and health problems, but they may be especially good at treating musculoskeletal conditions such as lower back pain, and less likely to prescribe drugs for that problem, according to a 2015 study in the *Journal of the American Osteopathic Association*.

LIMITATIONS: Like M.D.s, they don't have much time to spend with patients. The average osteopathic visit is actually a couple of minutes shorter than the average visit with an M.D., according to that same 2015 study.

CR'S ADVICE: A D.O. can serve as your doctor in any case where you might seek an M.D. More than half of them practice family medicine or pediatrics.

And by seeing a D.O., you get the benefit of his or her extra training in the musculoskeletal system.

Nurse Practitioner (N.P.)

TRAINING: Before someone can become an N.P., he or she must be a registered nurse (R.N.), which requires an undergraduate degree in nursing. N.P.s go on to advanced education and clinical training, earning either a master's or doctorate degree, specializing in an area such as family practice, pediatrics, or women's health, says Diane Padden, N.P., Ph.D., vice president of professional practice and partnerships at the American Association of Nurse Practitioners. **STRENGTHS:** N.P. education and training emphasize patient-centered care, which means that in addition to diagnosing and treating conditions, N.P.s focus on

health education and counseling. One study found that patients tend to be more satisfied after a visit with an N.P., and that those visits tend to be longer. In some states, N.P.s can practice independently. **LIMITATIONS:** Those with diagnostic dilemmas, such as an unexplained fever that has lasted a few weeks, should usually be referred to an M.D. or a D.O. **CR'S ADVICE:** It's fine to choose a nurse practitioner as your main healthcare provider and to have one provide routine care during an office visit. But you should expect to be referred to a physician for complicated problems.

Physician Assistant (P.A.)

TRAINING: Becoming licensed as a P.A. typically involves a three-year master's program with coursework in anatomy, physiology, pharmacology, diagnosis, and ethics, as well as training in areas

such as family medicine, internal medicine, emergency medicine, and pediatrics. Many P.A. programs also require some sort of patient-care experience, such as working as an EMT, a phlebotomist, or a registered nurse. **STRENGTHS:** They can do many of the same things as M.D.s and D.O.s, such as taking medical histories, doing physical exams, ordering X-rays and other tests, and prescribing medication. **LIMITATIONS:** P.A.s usually aren't trained to handle multiple complicated diagnoses or complex procedures on their own. And they can work only under a supervising physician. **CR'S ADVICE:** It's fine to rely on a P.A. for routine matters, such as a urinary tract infection or sprain, Lipman says. You can also go to them for follow-up visits for such conditions as high blood pressure. But avoid relying on them for complicated procedures.

Registered Nurse (R.N.)

TRAINING: Laws vary by state, but R.N.s generally have a Bachelor of Science degree in nursing, an associate's degree in nursing, or a diploma from an approved nursing program. **STRENGTHS:** R.N.s are vital members of a medical team, taking medical histories, assessing symptoms, and supporting patients. They tend to focus more on patient education, "for example, counseling someone with high blood pressure on how to take their blood pressure at home," Hingle says. That's because their training "tends to be a lot more relationship-focused than what doctors get in medical school." **LIMITATIONS:** R.N.s can't practice independently or write prescriptions, and they must work under the supervision of an M.D. or a D.O. **CR'S ADVICE:** You shouldn't rely on one as a primary-care provider. But R.N.s are a great resource at your doctor's office if you need diet or lifestyle counseling, or instructions on day-to-day treatment of a disease (such as monitoring blood sugar levels).

The Growth of Different Medical Professions, 2000-2016

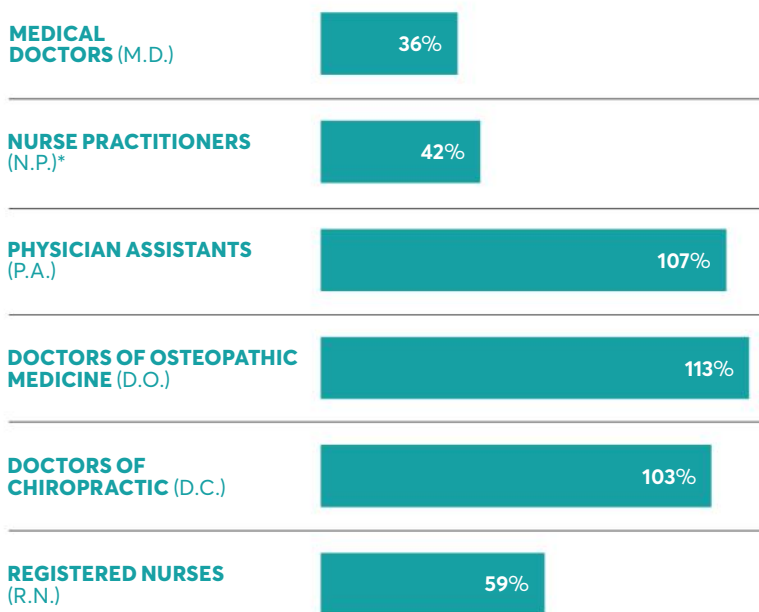

Source: Bureau of Labor Statistics (N.P.s, P.A.s, D.C.s, and R.N.s) and the Federation of State Medical Boards (M.D.s and D.O.s).

*Data available only for 2012-2016.

Who Should Be Your Main Healthcare Provider?

Whether you're the picture of health or you suffer from multiple conditions, you should have a primary-care provider (PCP). That's a person who handles routine health problems like sprains or the flu, keeps track of medication, and, if necessary, coordinates care with specialists. Without that point person, you're more prone to drug errors and more likely to have early symptoms go unseen until they develop into serious problems.

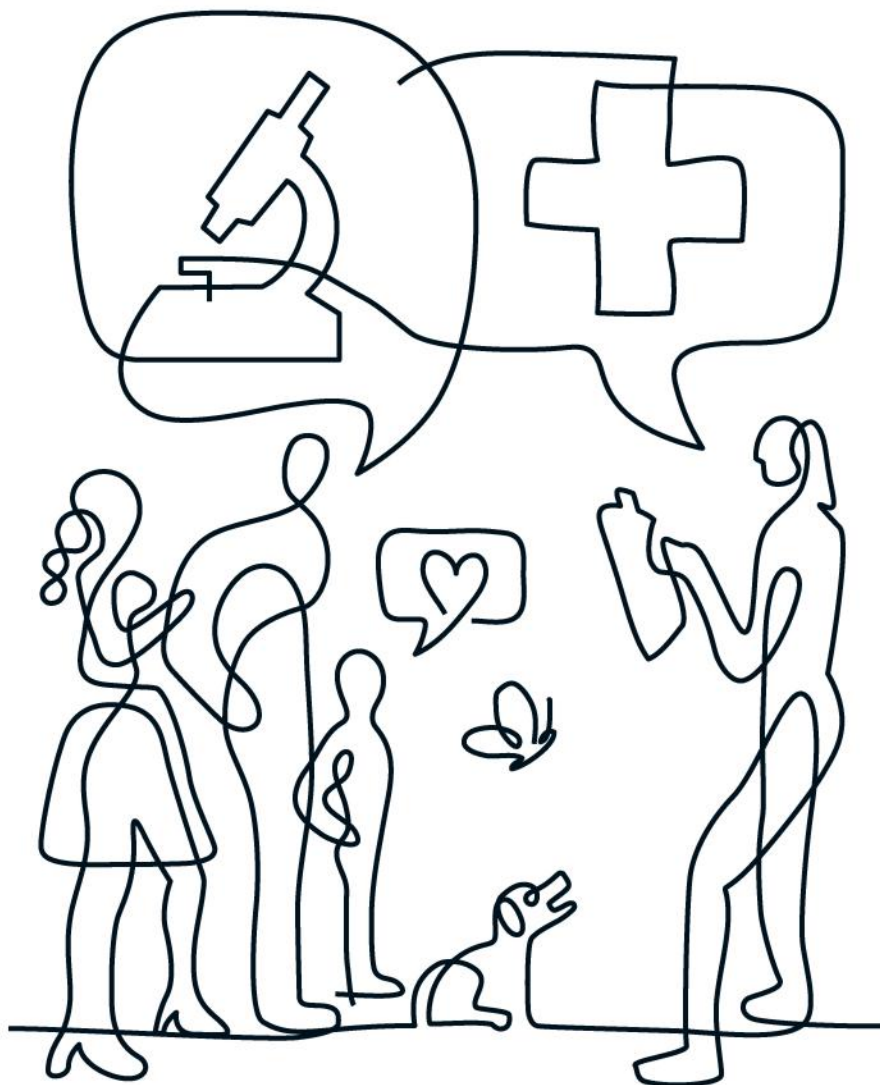

A PHYSICIAN TRAINED in internal medicine—typically called an internist—often plays the role of a PCP. (Medical doctors, or M.D.s, and doctors of osteopathic medicine, or D.O.s, can be internists.) But providers with other training can also be a good choice. Here's our guide to those providers, and when they can make sense for you.

FAMILIES WITH KIDS

If you want one doctor for the whole family, consider a board-certified family-practice physician, a doctor similar to an internist but

also trained to treat children. That way, you don't need a pediatrician, your family's medical records will stay in one office, and you'll form a relationship with a doctor familiar with everyone.

WOMEN

You could consider having an obstetrician/gynecologist as your PCP. OB-GYNs provide care that women need, like breast exams, birth control, and screening for cervical cancer. Or consider a certified nurse-midwife (C.N.M.), an advanced practice nurse with special

training in caring for women. But some research suggests that OB/GYNs may be less likely to screen patients for high cholesterol, diabetes, and colorectal cancer, or counsel them about diet and exercise. So if you're considering one (or a C.N.M.) as your primary provider, ask whether he or she is comfortable in that role.

PEOPLE 65 AND OLDER

Geriatricians are internists or family practitioners with special training in the health concerns of older people. While in short supply, they're especially helpful for frail or

cognitively impaired people whose family and friends feel overwhelmed by complicated treatment plans or multiple healthcare providers, says Annette Medina-Walpole, M.D., chief of geriatrics and aging at the University of Rochester Medical Center. Research suggests that people who see geriatricians may be less likely to end up in a hospital, possibly because those physicians are more likely to spot warning signs of dementia and to avoid risky medication. You can look for a geriatrician in your area at healthining.org.



Finding Dr. Right

If you went looking for a new doctor recently, chances are you turned to friends or family members for a recommendation. That's a reasonable place to start, but it should hardly be the final word, says Orly Avitzur, M.D., Consumer Reports' medical director. "After all, who's right for them may not be right for you," she says.

1 | CHECK INSURANCE.

Call your insurer for a list of approved doctors or ask whether the doctor you're considering is in-network. If you're on Medicare, look for physicians at medicare.gov/physiciancompare. **TIP** Doctors often add or drop insurance plans, so don't rely only on your insurer's online lists.

2 | VERIFY CREDENTIALS.

Look for a board-certified provider, which means the physician meets standards set by a professional organization. **TIP** To check on a physician's certification status, go to certificationmatters.org.

3 | CONSIDER HOSPITALS. The doctor you choose often

determines which hospital you can go to. Your insurer's website or medicare.gov/physiciancompare will list his or her hospital affiliations.

TIP Go to CR.org/hospitalratings to see how hospitals in your area score on avoiding infections and on other measures.

4 | LOOK FOR WARNING SIGNS.

It's not easy to find out about a doctor's disciplinary history for things like sexual misconduct or substance abuse. A good place to start: docinfo.org, run by the Federation of State Medical Boards, which represents state agencies that license and discipline physicians.

TIP If your search lists anything under "Actions," click on the link, which should take you to a state's website, where you may learn more about the doctor.

5 | FOLLOW THE MONEY.

The government collects data on the money doctors get from drug and medical-device companies. A physician who receives large payments may be more likely to recommend a company's device or drug, even if it might not be best for you.

TIP The nonprofit journalism group ProPublica keeps a database of how much industry money physicians receive, at projects.propublica.org/docdollars.

6 | CHECK OUT THE OFFICE.

Use your first appointment as a test run. Does the doctor listen, answer questions fully, and explain your diagnosis and treatment?

TIP Consider the whole team. Is the staff respectful and efficient? How long is the wait for a routine visit? —Catherine Roberts

When to See a Specialist

Certain complex medical conditions call for more than a primary-care provider.

SOME HEALTH PROBLEMS are so clear-cut or serious that, if insurance allows, it's worth going straight to a specialist. Someone with a history of skin cancer who develops a new lesion should see a dermatologist, for example. But it's not always so straightforward, and part of your primary-care provider's job is to decide when a specialist is needed, says Marvin M. Lipman, M.D., CR's chief medical adviser. While a neurologist may be necessary, say, for persistent migraines or an allergist to pinpoint allergy triggers, a PCP can often manage both. Of course, sometimes a specialist's

care is crucial. Here's when your PCP might refer you to one, or when you should ask to see one.

YOU RECEIVE A SERIOUS DIAGNOSIS.

An oncologist is clearly needed if you learn that you have cancer, as is a cardiologist if you have a heart attack. But specialists also improve outcomes for certain other conditions, such as a neurologist for people with Parkinson's.

YOU HAVE A COMPLEX PROBLEM.

A PCP can handle, say, osteoarthritis, but you may need a rheumatologist for severe rheumatoid arthritis.

THE DIAGNOSIS IS UNCLEAR.

Diagnosis can be difficult for uncommon problems such as cystic fibrosis. "PCPs encounter them so infrequently they may not recognize them," Lipman says.

YOU'RE NOT IMPROVING. Maybe back pain lingers despite anti-inflammatories and physical therapy. "If things aren't helping after a reasonable time," Lipman says, "ask to see a specialist."

A GUIDE TO SPECIALISTS

ALLERGIST/IMMUNOLOGIST:

For allergies, asthma, and immune-system disorders.

DERMATOLOGIST: For acne, eczema, melanoma, and other problems with skin, hair, nails, and the lining of the mouth, nose, and eyelids.

ENDOCRINOLOGIST: For diabetes, osteoporosis, thyroid diseases, and other gland and hormone disorders.

NEUROLOGIST: For dementia, brain injuries, epilepsy, and brain, nerve, and spinal-cord disorders.

ORTHOPEDIST: For injuries to and diseases of the bones, joints, ligaments, muscles, and tendons.

OTOLARYNGOLOGIST: For hearing loss, chronic sinusitis, and ear, nose, and throat (ENT) disorders.

PSYCHIATRIST: For substance abuse and all mental health issues.

NON-M.D. SPECIALISTS: These include podiatrists (who focus on feet); chiropractors (with special training helpful for some back problems); physical therapists; and dietitians.

How to Get More From Your Doctor Visit

Almost half of primary-care doctors in the U.S. typically spend 15 minutes or less with their patients. Here are some ways to make the most of those minutes.

1 | Plan ahead. It's easy to forget what you want to ask when you're being poked and prodded, says Mary Talen, Ph.D., director of primary-care behavioral health education at Northwestern University's Family Medicine Residency Program in Chicago. She has found that writing down concerns ahead of time greatly improves doctor-patient communication.

2 | Prioritize. Identify your three main health concerns and talk about the most important one first, suggests Marvin M. Lipman, M.D., Consumer Reports' chief medical adviser. That's the one your doctor will spend the most time on. If you have a longer list, ask whether a lengthier visit is possible when you schedule your appointment.

3 | Bring your meds. At least once a year bring in all your prescription and OTC drugs and supplements so your doctor can check for unnecessary ones and interactions. And if it's the first time you're seeing a doctor, have your previous doctor send copies of your medical records.

4 | Take notes. Don't expect to remember everything your doctor says, especially if you're not feeling well or you get a worrisome diagnosis. Write it down, record it, or bring someone with you to take notes.

5 | Take advantage of your care team. Clear communication may not be your doctor's strength. But there often are people in the office trained to talk with patients, and they may have more time, Talen says. So ask, for example, whether

the office has a dietitian to discuss weight loss, a diabetes educator to go over strategies for managing the condition, or a nurse who can better explain how to give yourself an injection.

6 | Expect quality time.

Physicians today spend much of their time with their back to patients as they enter data into a computer. That's because of the electronic health records they now use, which can make drug errors less likely and ensure that doctors cover essential points. But that can also make visits impersonal. If you think that your doctor focuses too much on the screen or that your concerns are routinely left unaddressed, consider looking for a new physician, Lipman suggests. —Catherine Roberts

How 'Natural' Can Hurt You

Naturopathic doctors promise more personalized and 'natural' care than regular M.D.s. But critics say their training isn't rigorous and their treatments are often unproved.

AMONG THE MOST controversial healthcare professionals you might run into these days are those who practice what's known as naturopathic medicine.

That approach to healthcare is based on the belief that the human body possesses "an inherent self-healing" ability, according to the American Association of Naturopathic Physicians. Naturopathic practitioners resist drugs and surgery, relying instead on giving patients lots of attention and personalized advice, and turning to a variety of "natural" or "holistic" treatments.

Those include approaches—such as changes in diet, exercise, and lifestyle—that medical doctors (M.D.s) and doctors of osteopathic medicine (D.O.s) also often embrace.

But critics say that many keystones of naturopathic care, such as homeopathy and intravenous vitamin treatment, haven't been scientifically proved.

CONFUSING DISTINCTIONS

To make matters even more confusing for consumers, there are two main branches of naturopathic practitioners: naturopathic doctors (N.D.s), who have graduated from a four-year naturopathic school and passed a licensing exam given by the Council on Naturopathic Medical Education; and unlicensed naturopaths, who have not completed those steps but practice anyway. That's generally legal as long as they stick to basic lifestyle advice.

The American Association of

Naturopathic Physicians says it wants N.D.s in all states to be recognized as licensed medical professionals, because that would differentiate its members from unlicensed naturopaths.

And it argues that N.D.s should be allowed to work as primary-care physicians, prescribe medication, diagnose diseases, and seek insurance payment just like M.D.s and D.O.s.

Lobbying by the AANP has prompted 15 state legislatures to consider bills that would expand or clarify the scope of what N.D.s can do.

But critics—including the American Academy of Family Physicians, which represents many primary-care doctors—worry that granting N.D.s the same rights and privileges as M.D.s and D.O.s could harm consumers.

They say that N.D.s aren't as rigorously trained as medical doctors—who usually study for about a decade before practicing on their own—and that many naturopathic treatments are ineffective and potentially dangerous.

A FIGHT FOR LEGITIMACY

The scope of what N.D.s can now do varies widely by state.

In 20 states plus the District of Columbia, N.D.s are generally allowed to order certain medical tests, such as blood tests and X-rays, and write at least some prescriptions. But in other states they are no different from naturopaths: restricted to offering health advice and nonprescription treatments.

The American Association of

Naturopathic Physicians says that distinguishing between N.D.s and untrained naturopaths would protect consumers. "Without licensure, it's kind of the Wild West," says Robert Kachko, an N.D. in Connecticut and a board member of the organization. "If anyone can call themselves a naturopath, you end up with people going to completely untrained practitioners, thinking that they're seeing a real doctor."

But opponents worry that allowing N.D.s to practice like M.D.s will add to the confusion. "Patients can easily be misled into thinking that an N.D.



license is the same as an M.D.'s," says Britt Hermes, a former naturopathic doctor who says she grew disillusioned with the field after observing what she considered unethical treatment of cancer patients. "It's essentially allowing them to practice medicine without any real medical training."

DUBIOUS SCIENCE

Timothy Caulfield, a professor of health law at the University of Alberta in Edmonton, Canada, and a longtime skeptic of alternative medicine, says he understands why naturopathic medicine appeals to some consumers:



N.D.s are attentive and treatment plans are personalized.

The problem, Caulfield says, is that many of their treatments aren't evidence based. "I went to a naturopath and it was a totally pleasant experience," he says. "But I left with \$250 in homeopathic solutions and herbal supplements that are completely useless."

Homeopathy, for example, is based on the notion that tiny doses of a toxin can cure certain medical conditions. (Drinking small doses of pollen dissolved in large quantities of water to cure a pollen allergy, for example.) But a large and growing body of research has found that homeopathy doesn't work any better than a placebo, or sugar pill.

Some critics say that even less contentious parts of naturopathy tend to be steeped in pseudoscience. "No one disagrees that diet and lifestyle are important," says Michael Munger, M.D., president of the AAFP. "But a lot of the specifics naturopathy offers are bogus."

For example, N.D.s sometimes base dietary advice on a patient's blood type. But a 2013 review in the *American Journal of Clinical Nutrition* concluded that there was no scientific evidence to back that approach.

WHEN 'NATURAL' ISN'T SAFE

N.D.s say that homeopathy and other "natural" therapies are worth trying first because they're less toxic than pharmaceuticals. In fact, safety is a key selling point of naturopathic medicine. N.D.s call it the "therapeutic order," meaning that practitioners should start with the safest treatments available. "We're not against drugs or surgery," Kachko says. "But that shouldn't be the first thing that we do."

The AAFP and other supporters of standard medical care say that argument fails on several counts.

First, M.D.s are also trained to focus on doing the least harm and to avoid riskier treatments until safer ones have been exhausted. "Naturopaths like to

say that they focus on health, while we just treat illness," Munger says. "But that's not true. Preventive healthcare is a staple of primary medicine."

Second, many treatments that N.D.s offer aren't in fact natural. "There is nothing natural about infusing massive doses of herbs or vitamins into your bloodstream," says Pieter Cohen, M.D., of the Harvard T.H. Chan School of Public Health, who studies the dietary-supplement industry.

And last, while standard medical care can harm patients, so can naturopathic care. There's no reliable information on how often such harm occurs, but there are some documented cases.

For example, the Food and Drug Administration reported last March that a 30-year-old woman died after receiving an intravenous infusion of curcumin (an ingredient in the spice turmeric) from a naturopathic practitioner to treat eczema, a relatively benign skin condition that's usually treated with steroids. According to the FDA, medical authorities concluded that the curcumin—which was deemed ineffective by a comprehensive 2017 scientific review—caused her death.

PROCEED WITH CAUTION

If you're considering naturopathic medicine, think twice. First talk with your primary-care doctor. If your goal is to improve your health through diet, exercise, or other lifestyle changes, your M.D. or D.O. may well be able to help just as well.

If you opt for naturopathic medicine anyway, be skeptical of claims that it's safer, more natural, or less profit-oriented than conventional medicine.

Remember that while N.D.s have more formal medical education than naturopaths, neither practitioner is as rigorously trained as an M.D. or a D.O.

And keep in mind that most naturopathic treatments are usually not covered by insurance, so you'll most likely have to foot the bill yourself.

—*Jeneen Interlandi*

Road Test

We conduct more than 50 tests on each vehicle at our 327-acre Auto Test Center. For complete road tests, go to CR.org/cars.



Doubling Down on Excellence

With a spot-on combination of handling, comfort, and a spiffy cabin, the redesigned BMW X3 is a joy to drive.

THE NEW X3 picks up where the outgoing version left off, keeping its title as the best-driving compact SUV. But the redesigned model ratchets up the comfort and luxury factors thanks to a more pampering cabin and reduced noise.

The BMW's turbocharged four-cylinder engine delivers ample power that's polished and nearly immediate when you hit the accelerator. Yet at 24 mpg overall, the X3 is among the most economical compact luxury SUVs.

The superbly smooth and responsive eight-speed automatic transmission works

well with the X3's standard all-wheel-drive system. That polished powertrain helps make the X3 a thoroughly engaging SUV to drive, as does its responsive and secure handling. The suspension absorbs bumps well, even though the ride quality skews to the firm side. Outside noises are impressively muted.

We love the interior's array of high-quality materials and their impeccable assembly. Even the cargo area is nicely finished.

The standard 10-way power front seats are firm and supportive, and provide all-day comfort. Hop in the rear seat and there's plenty of space for two adults.

Controls are relatively easy to learn, including the now simplified iDrive infotainment system. However, it takes time to get accustomed to using the electronic shift lever.

Automatic emergency braking isn't standard, a big oversight on a redesigned vehicle that starts at more than \$40,000.

LUXURY COMPACT SUVs

BMW X3

OVERALL SCORE

81

ROAD-TEST SCORE 92

HIGHS

Handling, braking, quietness, front-seat comfort, fit and finish, fuel economy

LOWS

Operating the gear shifter takes some getting used to

POWERTRAIN

248-hp, 2.0-liter four-cylinder turbo engine; 8-speed automatic transmission; all-wheel drive

FUEL

24 mpg on premium fuel

PRICE AS TESTED

\$53,745



Room for Improvement

The Buick Enclave delivers qualities that SUV buyers want, but some features are missing for the price.

THE REDESIGNED ENCLAVE is a strong entry for General Motors in the luxury SUV segment. It has features that shoppers look for in a luxury SUV, but the Enclave is hurt by its low mpg and the added cost to get key advanced safety systems that CR believes should come standard on all vehicles.

This Buick has a hushed cabin with enough room for up to seven passengers to stretch out. It also has a comfortable and relaxing ride, with particularly responsive handling for a large SUV.

The 310-hp V6 engine

is smooth and punchy, and it's paired with a nine-speed automatic transmission that has nearly imperceptible shifts. But even among three-row SUVs, the Buick's 18 mpg overall fuel economy is unimpressive. The awkward and confusing shifter is a nuisance, particularly when trying to park.

Given its price, the Enclave is a bit of a letdown in the luxury department. There are a couple of ill-fitting trim pieces, and the front seats have only two-way lumbar adjustment. The manually operated sunroof shades snap open in a clunky way, and only the driver's window has auto-up capability.

We like that the 8-inch touch-screen infotainment system has straightforward logic. But the screen is a tad far away and some buttons are a bit of a reach.

Forward-collision warning and automatic emergency braking are available only on top trims. They should be standard, particularly in a vehicle this pricey.

LUXURY LARGE SUVs

Buick Enclave

OVERALL SCORE

63

ROAD-TEST SCORE 87

HIGHS

Ride, quietness, interior room, powertrain, easy-to-use infotainment system

LOWS

Confusing gear selector, fuel economy, clunky manual sunroof shades

POWERTRAIN

310-hp, 3.6-liter V6 engine; 9-speed automatic transmission; all-wheel drive

FUEL

18 mpg on regular fuel

PRICE AS TESTED

\$55,680



A Luxury Misfire

The **GMC Terrain** lacks the premium features and driving acumen to compete with the best compact SUVs.

GENERAL MOTORS HAS positioned the new Terrain as a premium alternative to its corporate cousin, the Chevrolet Equinox. But we don't think it's worth the extra cost.

One of the Terrain's major shortcomings is the dash-mounted push-button gear selector. The buttons are low in the center console, forcing drivers to look down and away from the road when making a gear choice. It's distracting to use—which can be potentially unsafe—and it makes parking maddening.

The Terrain feels mundane through turns due to vague

steering, but it proved secure and predictable in our simulated emergency maneuvers. However, we found the ride too stiff and uncomfortable.

The 2.0-liter, turbocharged engine moves the SUV along smartly, and it's significantly punchier than the standard 1.5-liter turbo. But the nine-speed automatic transmission doesn't shift very smoothly or promptly. This powertrain combination produced an unimpressive 22 mpg overall.

Inside, the cabin is dreary, with lots of uninspiring hard plastic. The seats are reasonably comfortable, but they're covered in a coarse, unattractive fabric.

Making matters worse, the Terrain is loud. The engine sounds unrefined, and the elevated wind and road noise create a tiring din.

Forward-collision warning and automatic emergency braking are optional. We believe these safety systems should be standard on every vehicle.

COMPACT SUVs	
GMC Terrain	
OVERALL SCORE	55
ROAD-TEST SCORE 65	
HIGHS Acceleration from the 2.0-liter turbo, braking	
LOWS Loud cabin, stiff ride, agility, visibility, fit and finish, confusing gear selector, price	
POWERTRAIN 252-hp, 2.0-liter four-cylinder turbo engine; 9-speed automatic transmission; all-wheel drive	
FUEL 22 mpg on regular fuel	
PRICE AS TESTED \$36,950	



Wading Into New Waters

The all-new **Land Rover Range Rover Velar** ditches the brand's off-road ruggedness for sporty driving dynamics, sleek styling, and a high-tech cabin.

ONCE YOU START driving the new Velar, it's obvious this compact luxury SUV is a new breed of Land Rover. It sits lower than other Range Rover models and takes corners better, with quick steering and graceful handling over undulating roads. But the ride transmits nearly every bump to the cabin, and it can get jittery on rough surfaces.

The Velar feels perky because of a turbo four-cylinder engine that's helped along by its smooth and decisive eight-speed automatic transmission. But turbo lag and

an abrupt start/stop system can make in-town driving annoying. It's not as well-mannered as it should be for a high-priced luxury vehicle. The Velar gets 21 mpg overall on premium fuel, a bit below the segment average.

Land Rover's new dual-screen infotainment system dominates the high-caliber cabin. But the bottom screen is mounted too low and requires too many steps to execute everyday tasks.

The door handles slide out as you press the unlock button. The seats are comfortable and supportive, but we were surprised that the standard seat lacks lumbar adjustment.

Thick pillars and tapering glass make it difficult to see out of the back. And drivers might object to the clunky manual steering-wheel adjustments.

The Velar has standard low-speed automatic emergency braking and optional blind-spot warning. Its Overall Score is hurt by poor predicted reliability based on the brand's history.

LUXURY COMPACT SUVs	
Land Rover Range Rover Velar	
OVERALL SCORE	51
ROAD-TEST SCORE 76	
HIGHS Handling, fit and finish, standard automatic emergency braking	
LOWS Stiff ride, distracting controls, visibility, fuel economy	
POWERTRAIN 247-hp, 2.0-liter four-cylinder turbo engine; 8-speed automatic transmission; all-wheel drive	
FUEL 21 mpg on premium fuel	
PRICE AS TESTED \$59,503	

Ratings > **A Good Fit for All** Whether you want sporty handling, fuel efficiency, cargo space galore, or room for seven people, you'll find an SUV below that matches your needs.



Recommended	Make & Model	Overall Score	Price	Survey Results		Safety	Road-Test Results										
				Predicted reliability	Owner satisfaction		Road-test score	Overall MPG	Acceleration 0-60 MPH, sec.	Dry braking 60-0 MPH, ft.	Avoidance maneuver speed, MPH	Routine handling	Ride	Noise	Seat comfort front/rear	Controls	Cargo volume, cu. ft.
COMPACT SUVs																	
✓	Subaru Forester 2.5i Premium	84	\$27,145	↑	↑	Opt.	85	26	8.7	127	52.0	↑	↓	↓	↑/↑	↑	35.5
✓	Honda CR-V EX (1.5T)	83	\$28,935	↑	↑	Opt.	82	28	8.2	137	52.0	↑	↓	↑	↑/↑	↑	36.0
✓	Toyota RAV4 XLE	81	\$29,014	↑	↑	Std./↑	75	24	9.3	135	51.0	↑	↑	↑	↓/↑	↑	37.0
✓	Nissan Rogue SV	73	\$29,920	↑	↓	Std./↑	74	24	9.5	134	54.0	↓	↑	↓	↓/↑	↑	31.5
✓	Mazda CX-5 Touring	72	\$29,530	↓	↑	Std./↑	80	24	8.6	133	54.0	↑	↑	↑	↑/↑	↑	30.5
✓	Ford Escape SE (1.5T)	69	\$29,630	↓	↓	Opt.	75	23	10.1	132	50.0	↑	↑	↑	↓/↓	↑	34.0
	Volkswagen Tiguan SE	65	\$31,645	↓	↑	Opt.	84	25	10.3	131	52.0	↑	↑	↑	↑/↑	↑	33.0
	Chevrolet Equinox LT (1.5T)	65	\$33,730	↓	↓	Opt.	78	25	9.6	132	53.0	↑	↑	↑	↑/↑	↑	32.0
	Hyundai Tucson Value (1.6T)	57	\$28,670	↓	↓	Opt.	79	26	8.4	128	53.0	↑	↑	↑	↑/↑	↑	29.5
	GMC Terrain SLE (2.0T)	55	\$36,950	↓	↓	Opt.	65	22	7.2	128	54.0	↓	↓	↓	↑/↑	↓	24.0
LUXURY COMPACT SUVs																	
✓	BMW X3 xDrive30i	81	\$53,745	↑	↑	Opt.	92	24	7.7	128	50.5	↑	↑	↑	↑/↑	↓	32.0
✓	Porsche Macan S	80	\$63,290	↑	↑	Opt.	85	19	6.4	130	51.0	↑	↓	↑	↑/↑	↓	29.0
✓	Lexus NX 300	78	\$43,284	↑	↓	Std./↑	74	24	7.5	132	49.5	↑	↓	↑	↑/↑	↓	28.5
✓	Audi Q5 Premium Plus	78	\$51,570	↑	↑	Std./↑	83	24	6.8	130	52.5	↑	↑	↑	↑/↑	↓	27.0
✓	Acura RDX	73	\$38,990	↑	↓	Opt.	75	22	6.6	132	51.0	↓	↓	↑	↑/↑	↓	31.5
	Volvo XC60 T5 Momentum	66	\$50,040	↓	↑	Std./↑	79	23	8.0	124	52.0	↑	↓	↑	↑/↑	↓	34.0
	Mercedes-Benz GLC300	54	\$49,105	↓	↑	Std./↑	81	22	6.8	132	50.0	↑	↑	↑	↑/↑	↓	28.0
	Land Rover Range Rover Velar S	51	\$59,503	↓	↑	Std./↓	76	21	8.4	130	51.5	↑	↓	↑	↑/↑	↓	29.0
	Alfa Romeo Stelvio Ti	51	\$52,040	↓	↑	Opt.	74	24	7.0	132	52.5	↑	↑	↑	↓/↓	↓	26.5
	Jaguar F-Pace Prestige	47	\$53,895	↓	↑	Opt.	72	20	6.0	129	50.5	↑	↓	↓	↑/↑	↓	28.5
3-ROW LARGE & MIDSIZED SUVs																	
✓	Audi Q7 Premium Plus	90	\$68,695	↑	↑	Std./↑	96	20	6.7	127	50.0	↑	↑	↑	↑/↑	↓	35.5
✓	BMW X5 xDrive35i	76	\$70,050	↑	↑	Opt.	84	21	7.4	137	52.0	↑	↑	↑	↑/↑	↓	34.5
	Chevrolet Traverse Premier	67	\$49,945	↓	↑	Opt.	95	20	7.3	130	50.5	↑	↑	↑	↑/↑	↑	54.5
	Acura MDX Tech	66	\$51,410	↓	↓	Std./↑	79	21	6.8	135	52.0	↓	↑	↑	↑/↑	↓	34.0
	Volkswagen Atlas SEL (V6)	65	\$44,165	↓	↑	Opt.	84	20	8.7	135	51.0	↑	↑	↑	↑/↑	↑	50.5
	Infiniti QX60	64	\$51,920	↓	↓	Opt.	79	19	8.3	137	47.0	↓	↑	↑	↑/↓	↑	39.0
	Buick Enclave Premium	63	\$55,680	↓	↑	Opt.	87	18	7.4	130	53.5	↑	↑	↑	↑/↑	↓	48.5
	Volvo XC90 T6 Momentum	58	\$56,805	↓	↑	Std./↑	84	20	7.7	126	52.5	↓	↓	↑	↑/↑	↓	35.0
	GMC Acadia Denali	57	\$51,585	↓	↓	Opt.	83	19	6.8	130	53.5	↑	↑	↑	↑/↑	↑	40.5
	Land Rover Discovery HSE	47	\$69,260	↓	↓	Opt.	71	17	7.3	138	47.5	↓	↑	↑	↑/↓	↓	42.5

HOW WE TEST: Recommended models did well in our **Overall Score**, which factors in **Road-Test Results**, **Predicted reliability**, **Owner satisfaction**, and **Safety**, which includes crash-test results and the

availability of front-crash prevention features, such as forward-collision warning and automatic emergency braking at city or highway speeds. For these systems, NA means no such system is offered; Opt. means

it's available on some versions but not necessarily on the one we tested; and models with standard systems are rated from ↓ to ↑ based on how many of these features are standard. We also

deduct points from the **Overall Score** if a vehicle's shifter lacks fail-safes or is difficult to operate. Online subscribers can go to CR.org/cars for complete, up-to-date ratings.

Customer Care You can call us about your subscription at 800-333-0663.

Or write to us: Consumer Reports Customer Care
P.O. Box 2109, Harlan, IA 51593-0298
Please include or copy address label from issue.
(Allow four to six weeks for processing.)

Visit us online: CR.org/magazine

Use our website to: Renew or pay for your current subscription
Give a gift subscription • Change your address
Report a delivery problem • Cancel your subscription

Price In U.S., \$6.99 per issue, special issues \$7.99. In Canada, \$7.99 CAN per issue, special issues \$8.99 CAN (Goods and Services Tax included, GST #127047702). All other countries add \$10 per year to the U.S. price for shipping and handling.

Back Issues Single copies of previous 24 issues, \$7.95 each; previous two Buying Guides, \$14.49 each (includes shipping and handling). Please send payment to Consumer Reports, Attn.: Customer Care, 101 Truman Ave., Yonkers, NY 10703. Other ways to get Consumer Reports on the go: Google Play, iPad, Kindle, Nook, Readly, Texture, and Zinio.

Permissions Reproduction of Consumer Reports in whole or in part is forbidden without prior written permission (and is never permitted for advertising purposes). For questions about noncommercial, educational/academic uses of our content, please submit requests at CRreprints.com.

Mailing Lists We exchange or rent our print customer postal mailing list so that it can be provided to other publications, companies, and nonprofit organizations that offer products or services through direct mail. If you wish to have your name deleted from our list, please send your address label with a request for deletion from outside use to Consumer Reports, P.O. Box 2109, Harlan, IA 51593-0298. We do not exchange or rent customers' email addresses. You can review our complete privacy policy regarding Consumer Reports information products, services, and programs at CR.org/privacy.

Consumer Reports (ISSN 0010-7174) is published monthly, except twice in December, by Consumer Reports, Inc., 101 Truman Ave., Yonkers, NY 10703. Periodicals postage paid at Yonkers, N.Y., and at other mailing offices; Canadian postage, at Mississauga, Ontario (Canadian publications registration number 2665247, agreement number 40015148). Title Consumer Reports is a federally registered trademark in the U.S. Patent and Trademark Office. Contents of this issue copyright © 2018 by Consumer Reports, Inc. All rights reserved under international and Pan-American copyright conventions.

CR's No Commercial Use Policy To view the policy, go to CR.org/nocommercialuse.

Voting Paid subscribers may become voting members of CR by providing written acceptance of membership, by sending in a nomination for the board of directors, or by returning a ballot for the annual election of CR's directors.

Contributions Consumer Reports is an independent 501(c)3 nonprofit organization that works side by side with consumers to create a fairer, safer, and healthier world. Contributions are tax-deductible in accordance with the law. Donations of commonly traded securities or real estate will be accepted and immediately converted to cash. For additional information, email donorservices@cr.consumer.org. To donate, please send your tax-deductible contribution to Consumer Reports, Attn.: Donor Services, 101 Truman Ave., Yonkers, NY 10703 or go to CR.org/donate.

Charitable Gift Annuity Establishing a Consumer Reports Charitable Gift Annuity is an ideal way to accomplish your personal financial goals while supporting the mission of Consumer Reports. For additional information, please contact us at 877-275-3425 or bequests@cr.consumer.org.

Consumer Reports' Staff operates under contract between Consumer Reports and The NewsGuild of New York Local 31003, CWA.

Subscribers Send address changes to Consumer Reports, P.O. Box 2109, Harlan, IA 51593-0298. If the post office alerts us that your magazines are undeliverable, we have no further obligation to fulfill your magazines unless we have a corrected address within two years.

POSTMASTER Send all UAA to CFS (see DMM 507.1.5.2); **NON-POSTAL AND MILITARY FACILITIES** Send address corrections to Consumer Reports, P.O. Box 2109, Harlan, IA 51593-0298.

CANADA POST If copies are undeliverable, return to Consumer Reports, P.O. Box 481, STN MAIN, Markham, ON L3P 0C4.



Consumer Reports is a member of Consumers International, a federation of more than 220 consumer organizations from more than 115 countries working to protect and empower consumers throughout the world. For information, go to consumersinternational.org.

Please Remember CR in Your Will For information about how to make a bequest to Consumer Reports, please contact us at 877-275-3425 or bequests@cr.consumer.org.

Establish a Charitable Gift Annuity With Consumer Reports



A Consumer Reports Charitable Gift Annuity provides you with payments throughout your lifetime *and* supports our role as the independent, unbiased voice of consumers.

Make a gift of \$10,000 or more and you will receive lifetime payments, a partial tax-free return, and a tax deduction.

**For more information or
to request a complimentary brochure,
contact Nancy Smith at (914) 378-2604
or legacy@consumer.org**



Yes, I want to learn more about creating a Charitable Gift Annuity.

Yes, I am interested in other planned giving opportunities such as bequests or gifts of assets.

Name(s) _____

Address _____

Email _____

Telephone _____

CRM83USN

Return to: Planned Giving, 101 Truman Ave., Yonkers, NY 10703

Index

a

Accommodations services	Jun 17, 22
Air filters, home	
changing & cleaning	Nov 17, 12
Air purifiers	Nov 17, 8
costs	Nov 17, 10
Air-ambulance companies	May 17, 52
Assisted living	Oct 17, 28
contract details	Oct 17, 34
finances	Oct 17, 36
insurance	Oct 17, 40

AUTOMOBILE RATINGS

Alfa Romeo Giulia	Nov 17, 62
Alfa Romeo Stelvio	Dec 17, 62
Audi Q5	Nov 17, 63
BMW 530i xDrive	Jul 17, 63
BMW X3	Mar 18, 58
Buick Enclave	Mar 18, 58
Buick LaCrosse	May 17, 59
Chevrolet Bolt	Sep 17, 62
Chevrolet Equinox	Aug 17, 58
Chevrolet Traverse	Feb 18, 59
Chrysler Pacifica Hybrid	Oct 17, 63
Fiat 124 Spider	Jun 17, 58
Ford Escape	Jun 17, 59
Genesis G90	May 17, 58
GMC Terrain	Mar 18, 59
Honda Accord	Feb 18, 58
Honda Civic Si	Jan 18, 58
Honda CR-V (LX/EX)	Jun 17, 59
Honda Odyssey	Oct 17, 63
Hyundai Ioniq	Sep 17, 63
Hyundai Sonata	Feb 18, 58
Jaguar XE	Nov 17, 62
Jeep Compass	Aug 17, 58
Kia Cadenza	Jul 17, 62
Kia Niro	Sep 17, 63
Land Rover Discovery	Nov 17, 63
Land Rover Range Rover Velar	Mar 18, 59
Lincoln Continental	May 17, 58
Mazda CX-5	Aug 17, 59
Mini Cooper Countryman	Aug 17, 59
Nissan Armada	May 17, 59
Nissan Rogue Sport	Jan 18, 59
Porsche 718 Boxster	Jun 17, 58
Subaru Crosstrek	Jan 18, 59
Subaru Impreza	Jul 17, 62
Toyota Camry	Dec 17, 63
Hybrid	Feb 18, 59
Toyota C-HR	Jan 18, 58
Toyota Highlander	Jul 17, 63
Toyota Mirai	Oct 17, 62
Toyota Prius Prime	Sep 17, 62
Volkswagen Atlas	Oct 17, 62
Volkswagen Tiguan	Dec 17, 62
Volvo XC60	Dec 17, 63

AUTOMOBILES & AUTO EQUIPMENT

Best & worst lists	Apr 17, 30
Brand Report Card	Apr 17, 36
Buying new vs. used	Feb 18, 50
Coming in 2017	Apr 17, 38
Financing	Dec 17, 60
Gear shifters	
flawed designs	Apr 17, 20
In-car entertainment systems	Oct 17, 54
audio streaming	Oct 17, 57
Bluetooth phone calls	Oct 17, 58
in-dash navigation	Oct 17, 56
most and least distracting	Jan 18, 53
voice commands	Oct 17, 59
Insurance	
price disparities	Jul 17, 52
Intelligent high beams	Jan 18, 12
Owner satisfaction	Feb 18, 48
Profiles, 2017	Apr 17, 52
Ratings, 2017	Apr 17, 40
Reliability	Apr 17, 86
new cars	Dec 17, 52
used cars	Sep 17, 52

Safety systems	Aug 17, 52
Self-driving cars	Apr 17, 10
Small SUVs	Apr 17, 7
Sunroofs, exploding	Dec 17, 30
Tires	Apr 17, 17; Nov 17, 52
best by region	Jan 18, 16
Top Picks for 2017	Apr 17, 22
Used cars	Apr 17, 49
flood damage	Feb 18, 52
reliability	Sep 17, 52
Winter driving	Nov 17, 52

b-d

Back pain	Jun 17, 33
Beds-in-a-box	Mar 18, 30
Behavior taxes	Oct 17, 48
Blenders	
Vitamix vs. Kalerik	Nov 17, 39
Cable TV/internet services	Aug 17, 24
Chicken	
nutritional value	Oct 17, 44
Coffee	
add-ins	Mar 18, 13
beans and equipment	Oct 17, 8
packaging claims	Oct 17, 10
Cold & flu	Jan 18, 30
medicine labels	Jan 18, 37
treating symptoms	Jan 18, 33
vaccines	Jan 18, 41
Consumer action	
airline reform	Aug 17, 5
antibiotic-free chicken	
at Kentucky Fried Chicken	Jun 17, 8
arsenic in rice	Mar 18, 5
auto insurance discrimination	Mar 18, 5
consumer data security	Dec 17, 5
consumer empowerment Q&A	Sep 17, 5
Consumer Financial	
Protection Bureau	Aug 17, 5
CR digital privacy standard	Jun 17, 8
drug price transparency	Jan 18, 5
electric vehicle sales	May 17, 8
energy costs	Jun 17, 8
Equifax hack restitution	Feb 18, 5
exploding sunroofs	Feb 18, 5
food recall location details	Dec 17, 5
fraud	
restitution	Apr 17, 6
victim protection	Jan 18, 5
fuel economy	Apr 17, 6
furniture tipping	
hazards	Jul 17, 5; Jan 18, 5
hair dye safety	Jun 17, 8
hearing aids	Jul 17, 5; Nov 17, 5
hospital infections	May 17, 8
hot car child protection	Nov 17, 5
merger opposition	
health insurers	May 17, 8
media companies	Mar 18, 5
net neutrality	Aug 17, 5
recall reform	Nov 17, 5
recalled-car rental reform	Apr 17, 6
robocalls	Oct 17, 5
self-driving cars	Oct 17, 5
safety	Dec 17, 5
student debt	Oct 17, 5; Feb 18, 5
vehicle-to-vehicle	
communication	Jul 17, 5
Consumer Reports	
tough safety scoring	Apr 17, 6
Conversations about money	May 17, 44
Cordless drills	Dec 17, 8
attachments	Dec 17, 12
components	Dec 17, 11
Crackers	Jan 18, 42
toppings	Jan 18, 45
Credit cards	
cash-back	Sep 17, 46
Doctors	
degrees	Mar 18, 48
primary-care physicians	Mar 18, 53
specialists	Mar 18, 55
Door locks	Mar 18, 14
Driving	
distracted	Jan 18, 48
phone anti-distraction	
features	Jan 18, 54
seniors	Jul 17, 18
Drones	Mar 18, 18
Drugs	
prescription overabundance	Sep 17, 24
storage & disposal	Jun 17, 30
Dryers	Aug 17, 12
Samsung vs. LG	Oct 17, 14

e-g

Earphones	Jun 17, 18
Egg labeling	Feb 18, 12
Fire extinguisher use	Feb 18, 11
Fitness trackers	Aug 17, 8
Flexi-fridges	Feb 18, 14
Flooring	Aug 17, 44
Food	
antibiotics in	Nov 17, 30
shopping	Jul 17, 30
store-prepared	Jan 18, 15
weird products	Jul 17, 14
Frozen pizza	Feb 18, 34
Grain bowls	Oct 17, 42
Grills	Jun 17, 46; Mar 18, 11

h-k

Headphones	Jun 17, 18
Healthy eating	Nov 17, 18
antibiotics in food	Nov 17, 30
fat	Nov 17, 27
gluten	Nov 17, 32
packaging claims	Nov 17, 23
promoting in children	Nov 17, 22
salt	Nov 17, 24
sugar	Nov 17, 20
Heart health	May 17, 24
Home care	Dec 17, 40
help with bills	Dec 17, 46
hiring help	Dec 17, 50
supportive communities	Dec 17, 48
Home office equipment	Sep 17, 8
Home remodeling	Jul 17, 44
elder-friendly upgrades	Dec 17, 44
Homeowners insurance	Aug 17, 36
Insect repellent	Sep 17, 16
Instant Pot tips	Mar 18, 16
Insurance	
car	
price disparities	Jul 17, 52
homeowners	Aug 17, 36
iPhone X vs. iPhone 8	Feb 18, 13
Kitchen equipment	
appliance suites	Oct 17, 20
best bundles	Oct 17, 22
for healthy cooking	Nov 17, 34
multi-cookers	Nov 17, 38

l-p

Laundry detergent	
safety alert	Oct 17, 18
Laundry machines	
pairs	Aug 17, 12
Samsung vs. LG	Oct 17, 14
Lawn mowers	
electric	May 17, 9
Lightbulbs	Feb 18, 16
Mattresses	Mar 18, 22
beds-in-a-box	Mar 18, 30
types	Mar 18, 28
Microsoft hardware	
poor predicted reliability	Nov 17, 16
Multi-cookers	Nov 17, 38

Instant Pot tips	Mar 18, 16
Naturopathic medicine	Mar 18, 56
Nonstick pans	Jan 18, 13
Ovens	Jan 18, 15
Pain relief	
back pain	Jun 17, 33
Paint	
interior	May 17, 38
Pasta	
alternative ingredients	May 17, 14
Photo print-making services	Dec 17, 14
Pizza	
frozen	Feb 18, 34
unhealthy chain options	Feb 18, 37
Popcorn	Jun 17, 15

r-s

Remodeling	Jul 17, 44
Retirement	Mar 18, 42
healthcare expenses	Mar 18, 47
unexpected	Mar 18, 45
Robovacs	Jan 18, 18
Shopping	
best fall deals	Sep 17, 40
online	Dec 17, 20
haggling	Feb 18, 27
last-minute	Dec 17, 29
return policies	Dec 17, 26
safety	Dec 17, 26
scams	Dec 17, 28
paying less	Feb 18, 24
Smartphones	Jan 18, 24
iPhone X vs. iPhone 8	Feb 18, 13
Snack crackers	Jan 18, 42
toppings	Jan 18, 45
Soda alternatives	Oct 17, 52
Solar roof tiles	Sep 17, 18
Space heaters	Jan 18, 14
Stem cell treatments	Mar 18, 36
Strollers	Feb 18, 15
Sunscreens	Jul 17, 8

t-v

Talking about money	May 17, 44
Television sets	
4K	Nov 17, 44
best deals	Feb 18, 40
how to shop for	Nov 17, 49
satisfying lower-priced	
models	Nov 17, 47
Toilets	Feb 18, 18
wall-mounted	Feb 18, 21
Vacuums	Jun 17, 9
for allergy sufferers	Nov 17, 13
robotic	Jan 18, 18
Video	
4K content availability	Nov 17, 46
how to shoot	May 17, 18
streaming devices	Feb 18, 43
Voice assistants	
Alexa	Jan 18, 11

w-y

Washing machines	Aug 17, 12
Samsung vs. LG	Oct 17, 14
Winter driving	Nov 17, 52
Yogurts	
whole-milk	Aug 17, 18



LEARN

For an extended index covering five years of CR articles and ratings, go to [CR.org/5yearindex](https://www.consumerreports.org/5yearindex).

Beauty Blunders

These grooming products and services might leave a different kind of beauty mark

Go for the Glow ... Stay for the Spay?

While \$15 may be cheaper than local vet prices, we'll pass on this deal.
Submitted by Paul E. Zopf Jr., Greensboro, NC

Viva La Tan & SUNLESS

UV and Sunless Tanning Experts with Over 25 years of knowledge. With a custom-tailored plan, you can achieve that perfect glow for any occasion! We carry the Highest quality Sunless products and ingredients for your skin.

Viva La Tan & SUNLESS First Time Custom Airbrush Tan only \$20 Spray Booth only \$15

(New Clients Only) Some restriction apply. Valid with coupons. Not valid with any other offers. Exp. 3-4-17

Viva La Tan & SUNLESS One Month Unlimited Bed Tanning only \$29.95

(New Clients Only) Restrictions apply. Valid with coupons. Not valid with any other offers. Exp. 3-4-17

Get ready to fall in love with Sunless Tanning!

With an airbrush tan, we customize your color to provide a flawless, even, never streaky or orange tan. Let us change your mind about spray tanning! We use the finest equipment and best organic ingredients.

Free of Gluten, Parabens, Non-Nut Allergen, 100% Vegan

Let us help you bring out your inner bronze. God or Goddess!

Custom Airbrush Tan only \$20 Spray Booth only \$15



Moussed to Mediocrity

Finally! A product for people who are sick of having perfect hair days.
Submitted by Crosby Morgan, Acton, CA

imperfection.



Tressed to Kill?

We love a good pun but even so, this salon's name makes our hair stand on end.
Submitted by Emily Adler, Burlington, VT

Beauty Rest

We agree. If you want a dreamy hairdo, do your styling while awake!
Submitted by Peggy (last name withheld), via email

Never use while sleeping.

WARNING - To reduce the risk of burns, electrocution, fire, or injury to persons:

1. This appliance should never be left unattended when plugged in.
2. This appliance should not be used by, on, or near individuals with certain disabilities.
3. Use this appliance only for its intended use, as described in this manual. Do not use attachments not recommended by the manufacturer.
4. Never operate this appliance if it has a damaged cord or plug, if it is not working properly, or if it has been dropped, damaged, or dropped into water. Return the appliance to an authorized service center for examination and repair.
5. Keep the cord away from heated surfaces.
6. Do not pull, twist, or wrap line cord around appliance.
7. Never use while sleeping.
8. Never drop or insert any object into any opening or hose.

1" Curling Iron

25 Heat Settings
Max Temp 420°F

Pink is the new BLACK

Courage is always in style.



Be on the lookout for goofs and glitches like these. Share them with us—by email at SellingIt@cro.consumer.org or by mail to Selling It, Consumer Reports, 101 Truman Ave., Yonkers, NY 10703—and we might publish yours. Please include key information, such as the publication's name and date.

Car shopping?

Get a deal. Without the ordeal.



Finding the perfect set of wheels is easier than you think

- **Choose new or used:** Check reviews, ratings, and reliability data
- **Save:** With competitive, haggle-free, up-front pricing
- **Know:** All about financing, safety features, insurance, tires, and car seats

LET'S GO
[cr.org/buyacar](https://www.consumerreports.org/buyacar)

CR ConsumerReports™

